

METTERE

MUTO acoustic
ceiling tile solutions

 SOELBERG

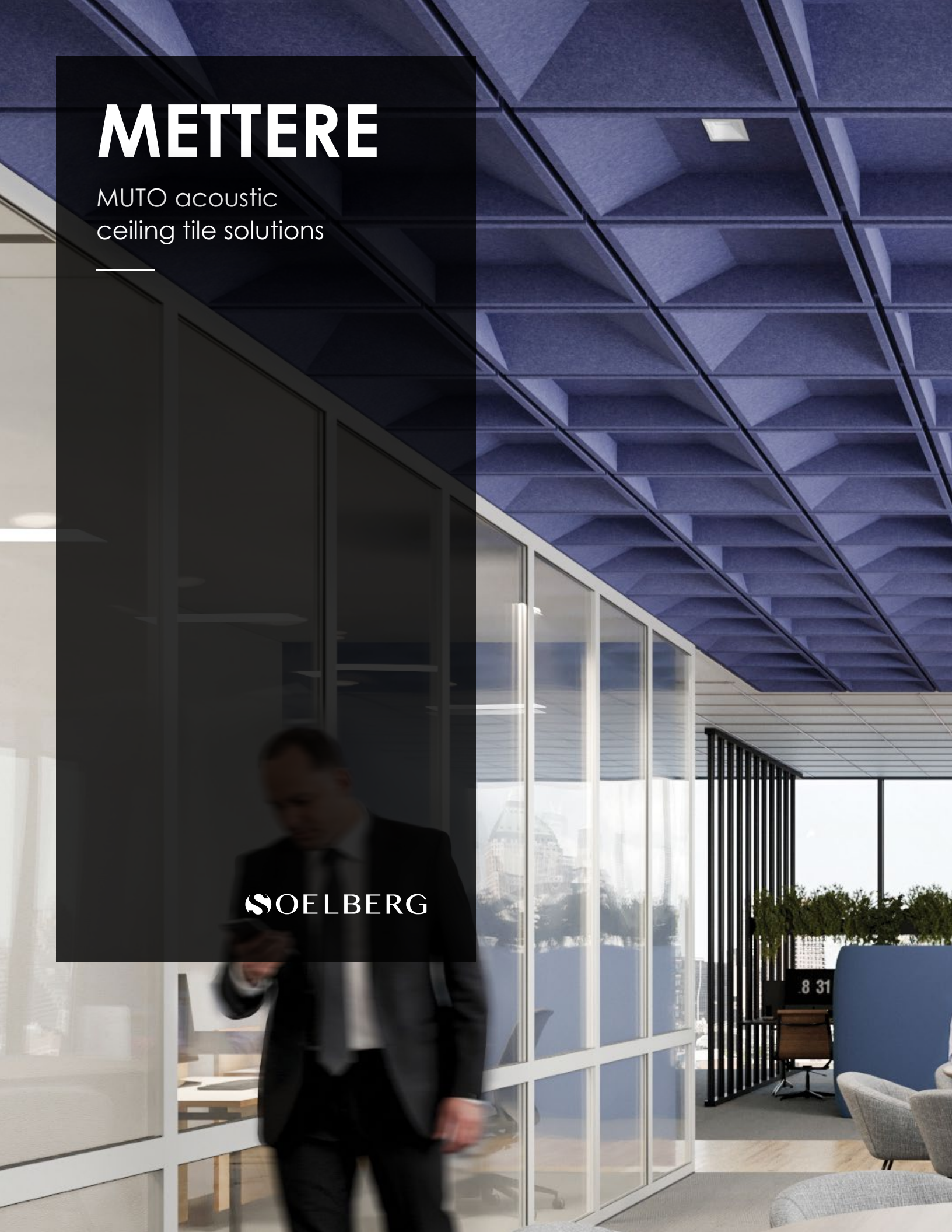

METTERE

MUTO acoustic ceiling tile solutions

Mettere acoustic ceiling tiles create dimensional, dynamic, design-forward ceilings that elevate any interior. Designed to fit into standard 15/16" T-grid systems, these tiles make it easy to transform ordinary ceilings into striking architectural features with endless possibilities. The collection includes 14 unique folded tile profiles available in 39 vibrant colorways, 12 beautifully printed WOODED finishes, or select custom printed colors to perfectly match your project's aesthetic.

SPECIFICATION

CONTENT	100% POLYESTER (PET) FELT
CORE THICKNESS	1/2" (12MM)
TILE PROFILE	14 UNIQUE TILE PROFILES
COLOR	39 STANDARD SOLID COLORS 12 WOODED PRINTS CUSTOM PRINTED COLOR
DIMENSIONS	TILE SIZE: 24" x 24" (NOMINAL) MIN DEPTH BELOW GRID: 1.25" MAX DEPTH BELOW GRID: 7"
GRID	15/16" T-GRID WITH 24" CLEARANCE
WEIGHT	3 - 4 LBS VARIES BY TILE
ACOUSTICS	TESTING IN PROGRESS
FIRE RATING	CLASS A ASTM - E84
ENVIRONMENTAL	DECLARE, MINDFUL MATERIALS & GREENGUARD GOLD CERTIFIED. MUTO IS PRODUCED FROM 100% RECYCLABLE PET FELT WITH A MINIMUM OF 60% PRE-CONSUMER RECYCLED CONTENT.
COLORFASTNESS	IN ACCORDANCE WITH ATCC 16.3 OPTION 3 THE COLOR CHANGE TO LIGHT AT 20 AFU WAS 4.5.
FINISH	MATTE
APPLICATION	INDOOR USE ONLY
LEAD TIME	2 WEEKS (STOCK COLOR & PRINT)
WARRANTY	2 YEARS



TOLERANCE & MAINTENANCE

PET core is a soft fibrous material. All dimensions and squareness are subject to +/- 1/16" tolerance.

Vacuum to remove dirt and dust. Remove spills or spots immediately using a clean damp cloth. Carpet and fabric cleaners can also be used to clean. (Always test an inconspicuous area first.) Compressed air may be used to dust in difficult or hard-to-reach areas. To disinfect, bleach can be used in accordance with CDC Cleaning & Disinfection instructions. The solution ratio is 5 tablespoons of bleach to 1 gallon of water | 4 teaspoons of bleach to 1 quart of water. Apply solution by spray and wipe off immediately. (Always test in an inconspicuous area first.)

HOW TO SPECIFY

It is easy to specify Mettere tiles with four simple steps.

1

SELECT YOUR PROFILE OR PROFILES

Rotate tiles and repeat for statement-making ceiling patterns. Or, combine various profiles for even more ceiling creativity.

2

CHOOSE YOUR COLOR

Select from 39 beautiful standard colors, 12 rich wood grain prints, or customize with any print color of the rainbow.

3

PROVIDE TILE QUANTITY

Whether you need one tile or hundreds of tiles, we have your ceilings covered. Let us know how many and they fit perfectly into 15/16" T-grid with 24" clearance above the grid.

4

NO HARDWARE NECESSARY

Fold your tiles and you're set.

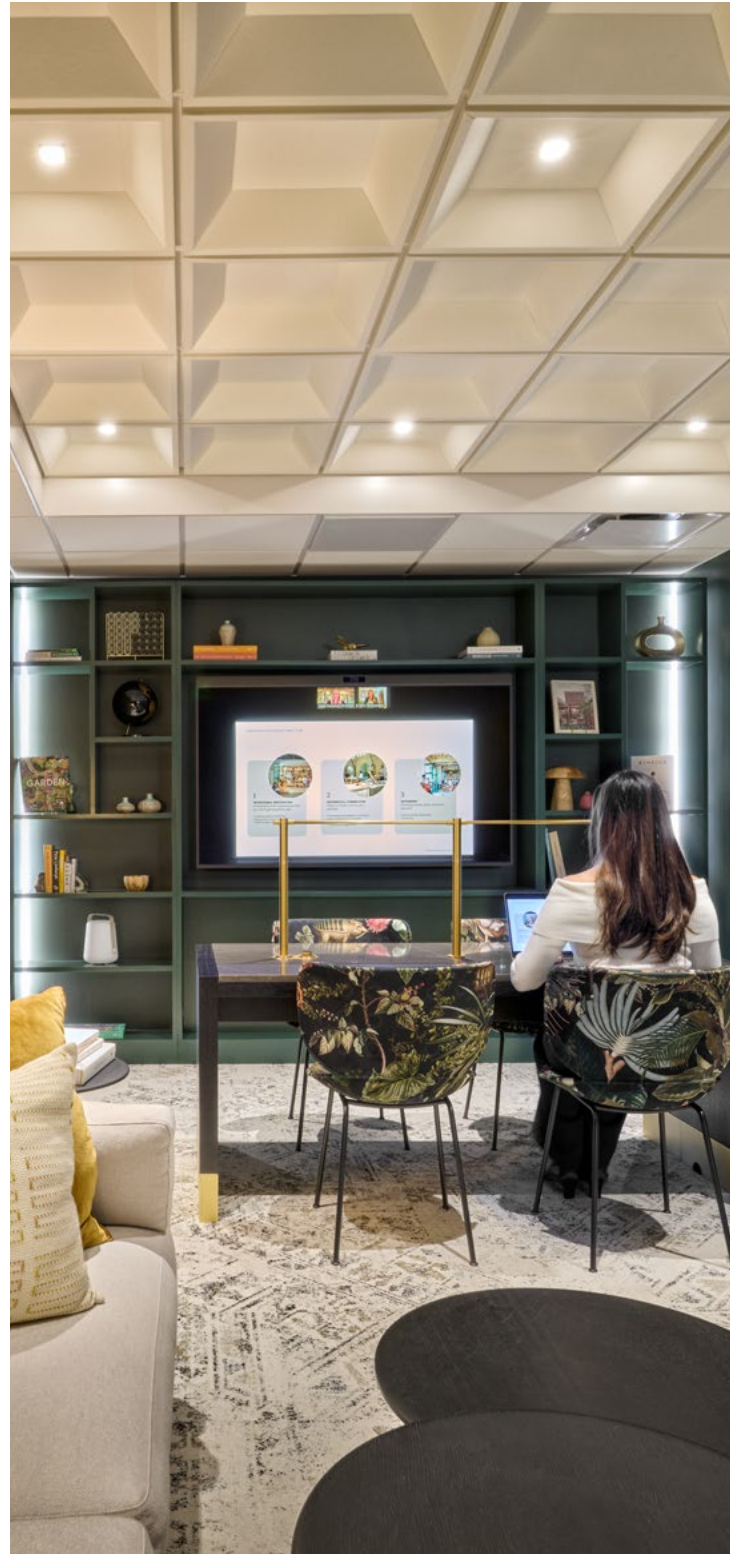

TILE PROFILE

14 UNIQUE PROFILE OPTIONS

SIZE: 24" x 24" (NOMINAL)
DEPTH RANGE FROM 1.25" - 7" BELOW THE GRID
ROTATE TILES 90°, 180° OR 270° FOR ENDLESS
PATTERN OPTIONS. COMBINE PROFILES FOR
EVEN MORE CEILING PATTERNING.

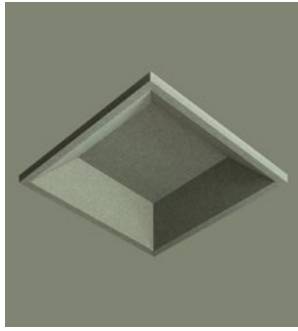

CASSONE [kah - sew - nay]

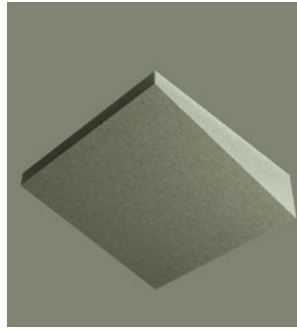

ERA [ey - rah]

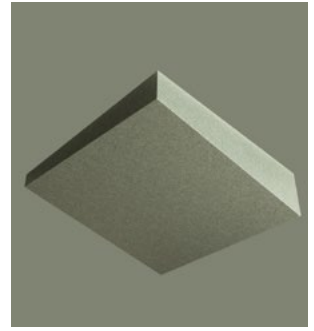

MENTIRE [main - tee - rey]

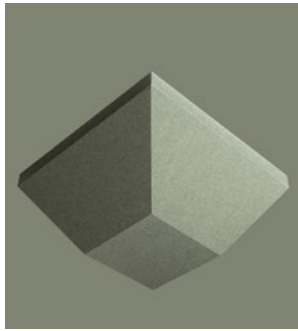

NOI [noy]

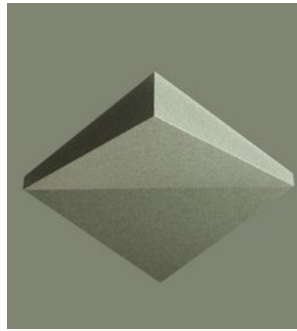

NORD [nord]

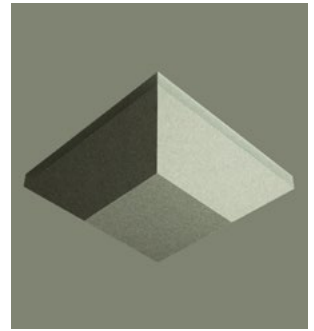

QUI [kwee]

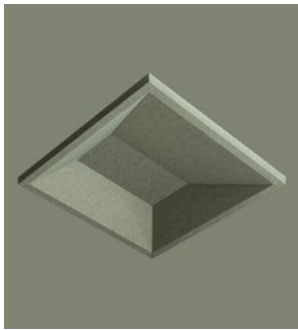

SALI [sigh]



SENTI [sane - tee]



SOLLEVI [sew - lay - vee]

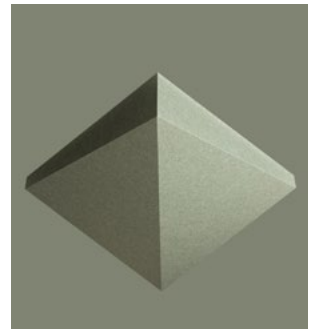

SUD [sood]



TOCCHI [toe - key]



UNO [oo - no]

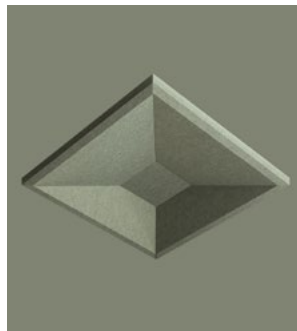

VEDI [vey - dee]

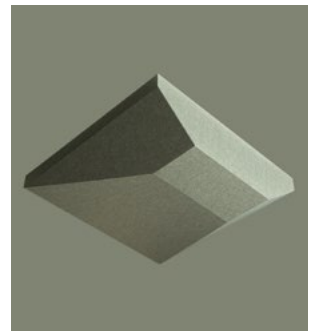

VOI [voy]

COLOR (STOCK)

MATTE COLOR

27 STANDARD COLORS
CUSTOM PRINT COLORS AVAILABLE
(CONTACT YOUR LOCAL SALES REP)
100% RECYCLABLE PET FELT

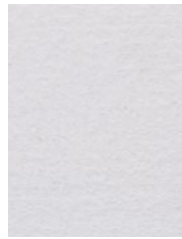

WHITE

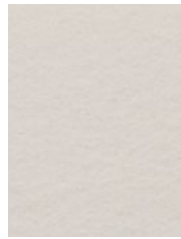

BONE

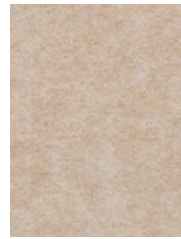

OATMEAL

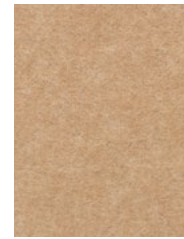

CAMEL



SAND

TOLERANCES

PET felt is made from 100% recyclable polyester plastic. Variation in depth will occur. Slight and consistent variations in color, density, texture are inherent to this core material and should be expected. Color, density and texture will vary by dye lot. MUTO is made with a 'felling' process which results in a textural heathered effect where the fibers consist of multiple tones and shades.



CASHMERE



FOG

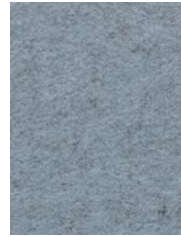

LAMB'S EAR

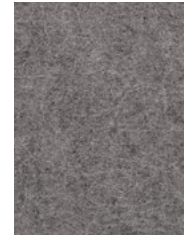

PEWTER



NORDIC KNIT

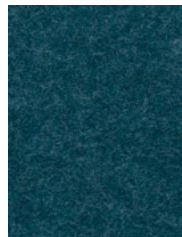

WINTER WATER

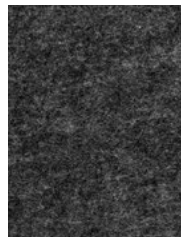

GRAPHITE



BLACK



MIDNIGHT



BLUEBERRY

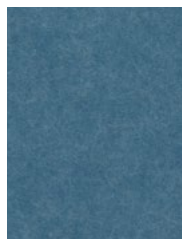

JUNIPER



SPLASH



STORM

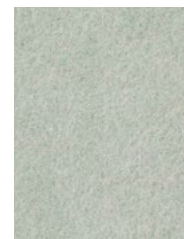

SEAFOAM



SAGE



ARTICHOKE



LICHEN



SUNSHINE

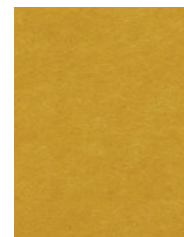

QUAKING ASPEN



CLEMENTINE



CHILI PEPPER



CURRANT

COLOR (NON STOCK)

EXTENDED LEAD TIME

MATTE COLOR

12 STANDARD NON-STOCKED COLORS
CUSTOM PRINT COLORS AVAILABLE
(CONTACT YOUR LOCAL SALES REP)
100% RECYCLABLE PET FELT

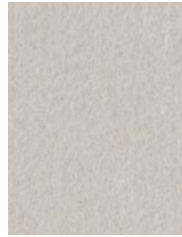

LATTE



CITY GRAY



BONDI BLUE



MARINE



WASHED DENIM

TOLERANCES

PET felt is made from 100% recyclable polyester plastic. Variation in depth will occur. Slight and consistent variations in color, density, texture are inherent to this core material and should be expected. Color, density and texture will vary by dye lot. MUTO is made with a 'felling' process which results in a textural heathered effect where the fibers consist of multiple tones and shades.

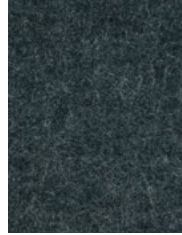

DEEP JUNGLE



COLLARD GREEN

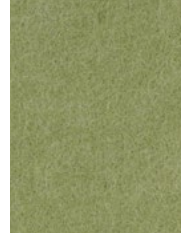

ASPARAGUS



PECAN



SIENA



RASPBERRY



PINK LEMONADE

WOODED COLOR

MATTE FINISH

12 PRINTED WOODED GRAINS
 1/2" CORE THICKNESS
 100% RECYCLABLE PET FELT

TOLERANCES

PET felt is made from 100% recyclable polyester plastic. Slight and consistent variations in color, density, texture are inherent to this core material and should be expected. Color, density and texture will vary by dye lot. MUTO is made with a 'felling' process which results in a textural heathered effect where the fibers consist of multiple tones and shades.

Please request physical samples as colors are represented differently with different computer monitors.

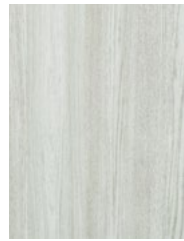

WHITE WASHED OAK

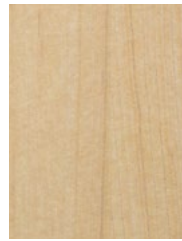

BLONDE MAPLE



NATURAL ASH

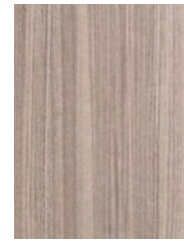

AGED ASH



SMOKED ASH

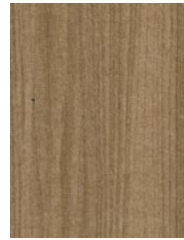

AMBER ASH



WARM WALNUT



NATURAL WALNUT



BLACK WALNUT



WEATHERED PINE



CARBON WALNUT



CHARRED OAK

TILE GRAIN DIRECTION

GRAIN FOLLOWS ARROW

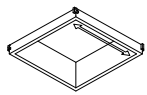

CASSONE

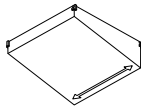

ERA

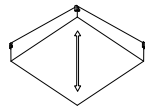

MENTIRE

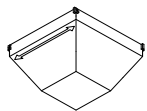

NOI

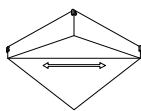

NORD

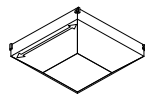

QUI

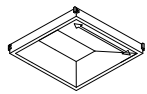

SAI

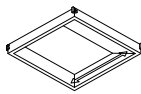

SENTI

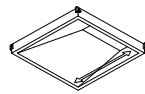

SOLLEVI

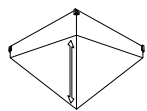

SUD

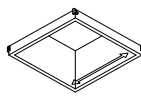

TOCCHI

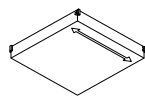

UNO

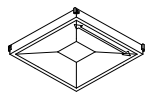

VEDI

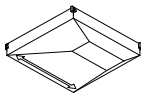

VOI

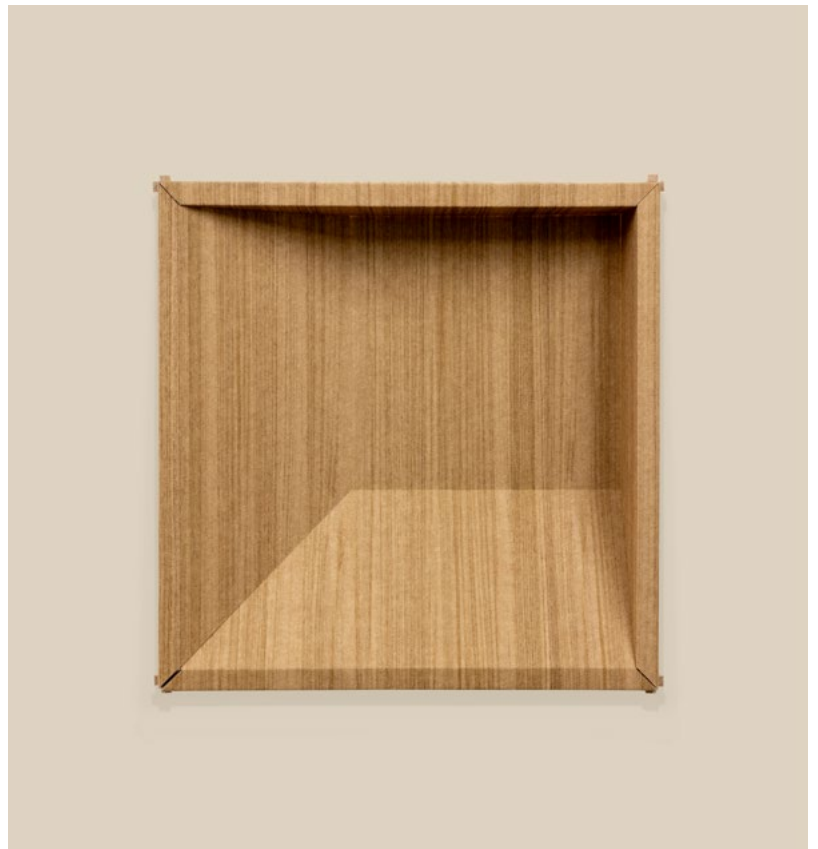

TILE DIMENSIONS

14 UNIQUE PROFILES

TILE SIZE: 24" x 24" (NOMINAL)

TILE MINIMUM DEPTH BELOW THE GRID: 1.25"

TILE MAXIMUM DEPTH BELOW THE GRID: 7"

EACH TILE IS UNIQUE AND THE DEPTH AND SIZE OF PLANE OR FOLDED SURFACE IS DIFFERENT. PLEASE REFER TO INDIVIDUAL TILE SIZE AND SHAPE.

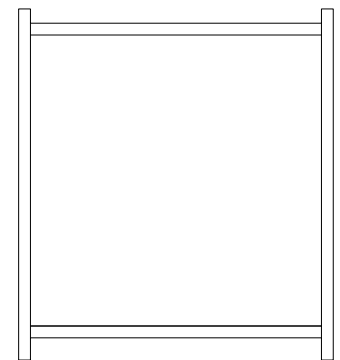
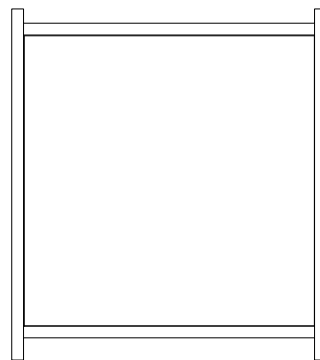
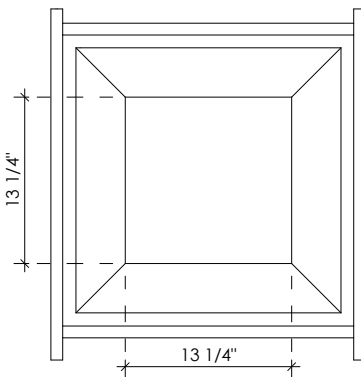
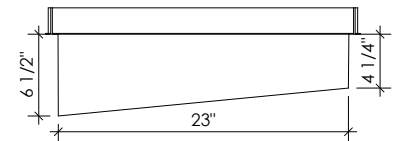
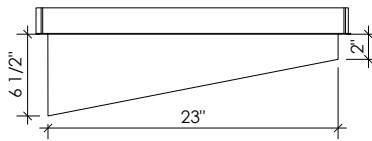
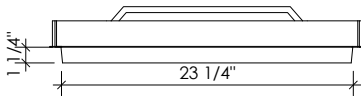
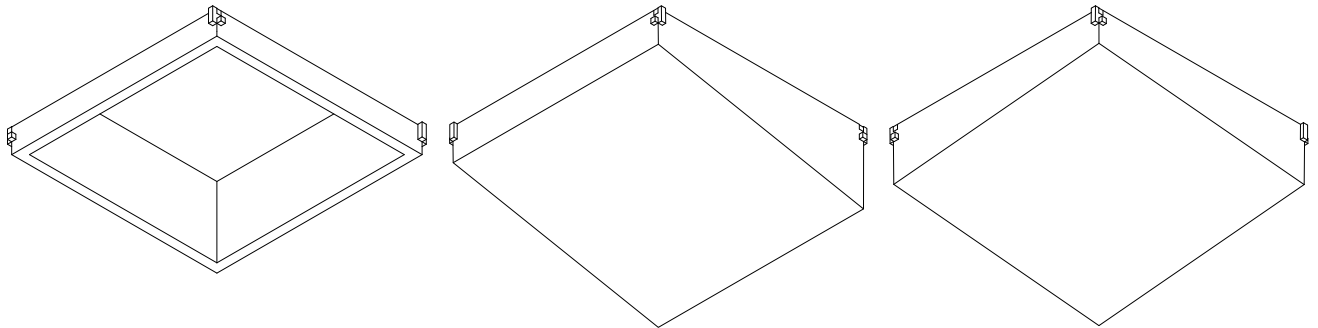

CASSONE DIMENSIONS (NOMINAL)
WEIGHT : 3 LBS

ERA DIMENSIONS (NOMINAL)
WEIGHT: 3.11 LBS

MENTIRE DIMENSIONS (NOMINAL)
WEIGHT: 3.9 LBS

TILE DIMENSIONS CONTINUED

14 UNIQUE PROFILES

TILE SIZE: 24" x 24" (NOMINAL)

TILE MINIMUM DEPTH BELOW THE GRID: 1.25"

TILE MAXIMUM DEPTH BELOW THE GRID: 7"

EACH TILE IS UNIQUE AND THE DEPTH AND SIZE OF PLANE OR FOLDED SURFACE IS DIFFERENT. PLEASE REFER TO INDIVIDUAL TILE SIZE AND SHAPE.

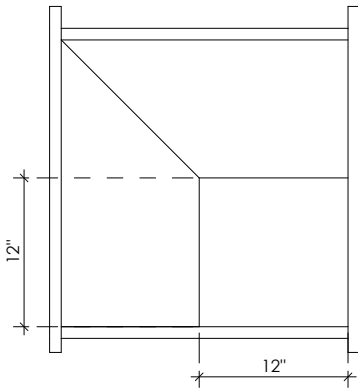
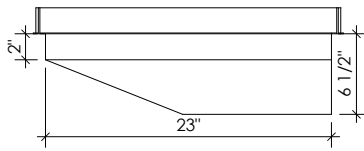
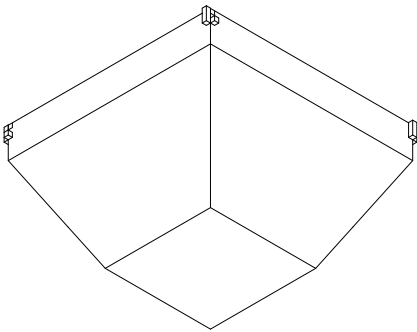

NOI DIMENSIONS (NOMINAL)
WEIGHT: 3.7 LBS

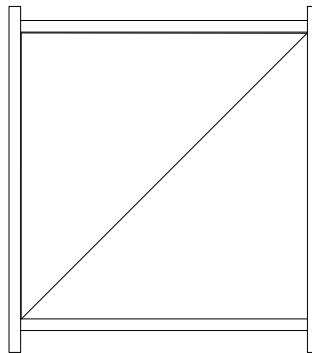
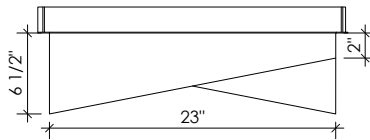
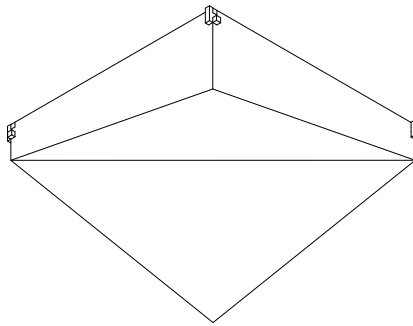

NORD DIMENSIONS (NOMINAL)
WEIGHT: 3.10 LBS

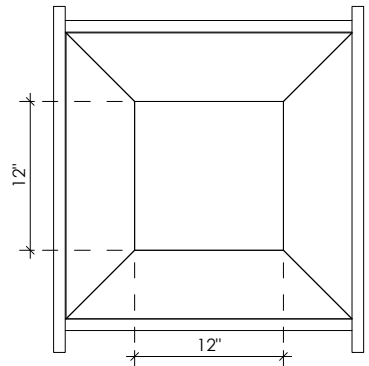
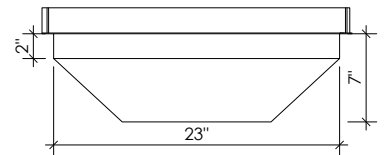
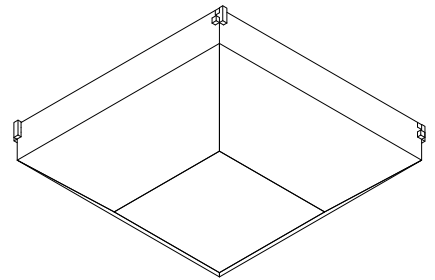

QUI DIMENSIONS (NOMINAL)
WEIGHT: 3 LBS

TILE DIMENSIONS CONTINUED

14 UNIQUE PROFILES

TILE SIZE: 24" x 24" (NOMINAL)

TILE MINIMUM DEPTH BELOW THE GRID: 1.25"

TILE MAXIMUM DEPTH BELOW THE GRID: 7"

EACH TILE IS UNIQUE AND THE DEPTH AND SIZE OF PLANE OR FOLDED SURFACE IS DIFFERENT. PLEASE REFER TO INDIVIDUAL TILE SIZE AND SHAPE.

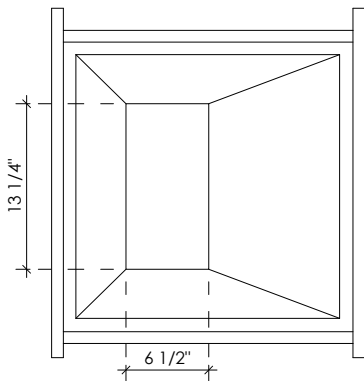
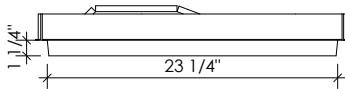
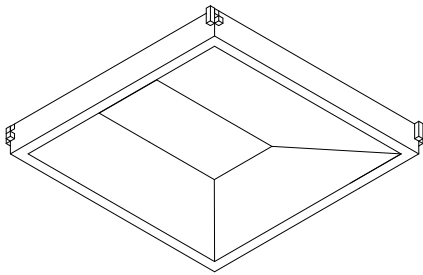

SAI DIMENSIONS (NOMINAL)
WEIGHT: 3 LBS

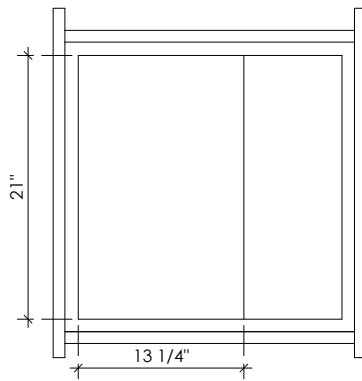
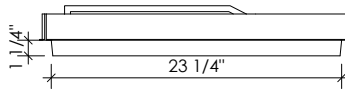
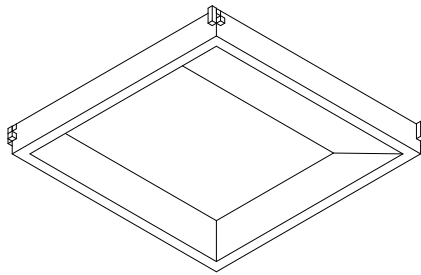

SENTI DIMENSIONS (NOMINAL)
WEIGHT: 3.3 LBS

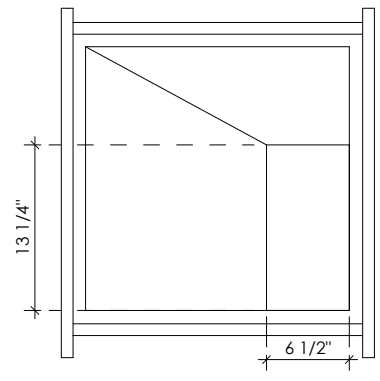
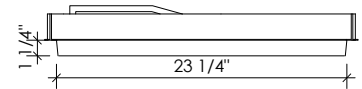
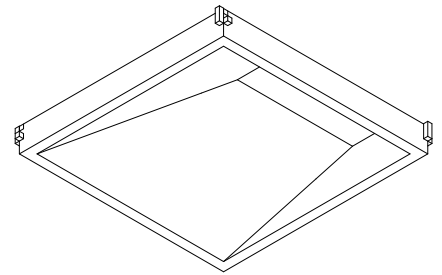

SOLLEVI DIMENSIONS (NOMINAL)
WEIGHT: 3 LBS

TILE DIMENSIONS CONTINUED

14 UNIQUE PROFILES

TILE SIZE: 24" x 24" (NOMINAL)

TILE MINIMUM DEPTH BELOW THE GRID: 1.25"

TILE MAXIMUM DEPTH BELOW THE GRID: 7"

EACH TILE IS UNIQUE AND THE DEPTH AND SIZE OF PLANE OR FOLDED SURFACE IS DIFFERENT. PLEASE REFER TO INDIVIDUAL TILE SIZE AND SHAPE.

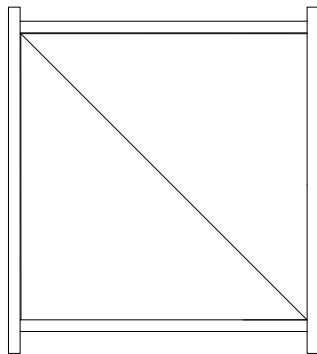
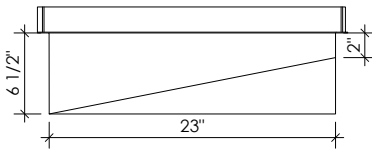
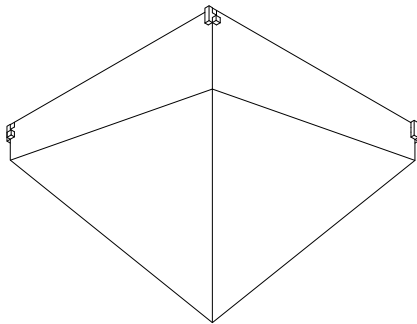

SUD DIMENSIONS (NOMINAL)
WEIGHT: 3.8 LBS

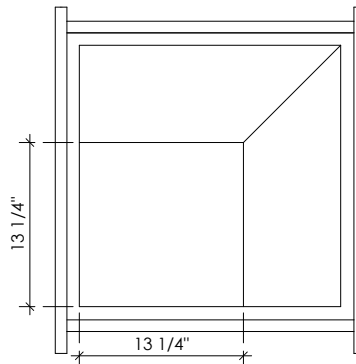
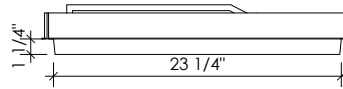
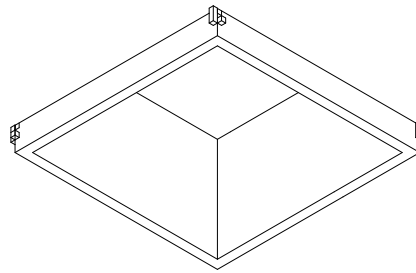

TOCCHI DIMENSIONS (NOMINAL)
WEIGHT: 3.2 LBS

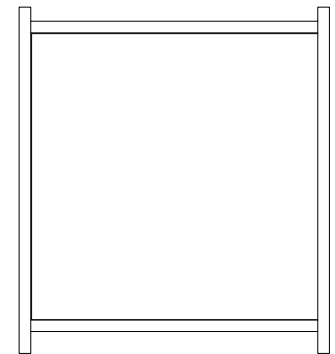
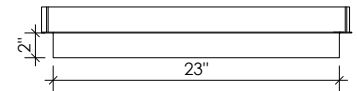
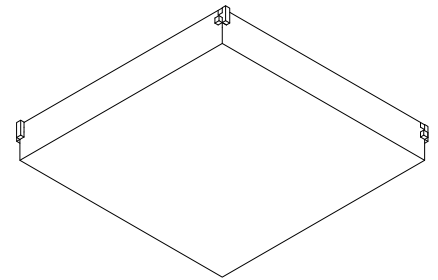

UNO DIMENSIONS (NOMINAL)
WEIGHT: 3 LBS

TILE DIMENSIONS CONTINUED

14 UNIQUE PROFILES

TILE SIZE: 24" x 24" (NOMINAL)

TILE MINIMUM DEPTH: 1.5"

TILE MAXIMUM DEPTH: 3.5"

EACH TILE IS UNIQUE AND THE DEPTH AND SIZE OF PLANE OR FOLDED SURFACE IS DIFFERENT. PLEASE REFER TO INDIVIDUAL TILE SIZE AND SHAPE.

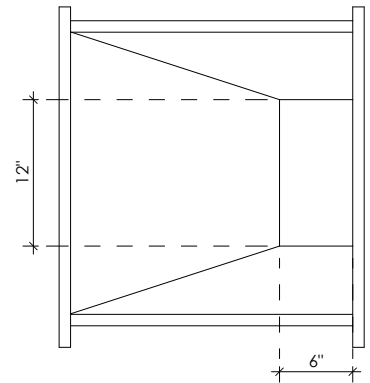
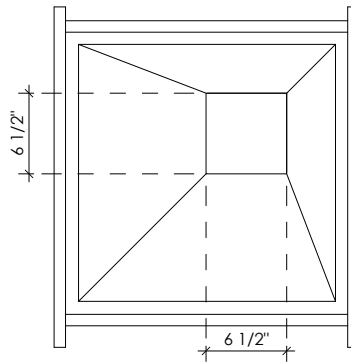
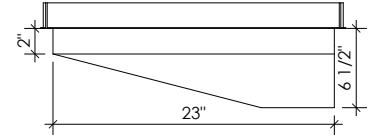
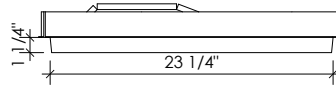
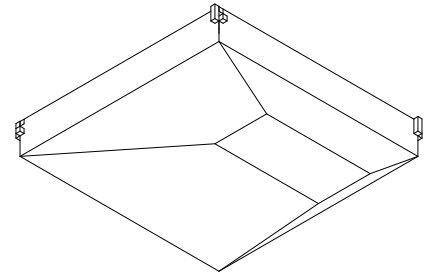
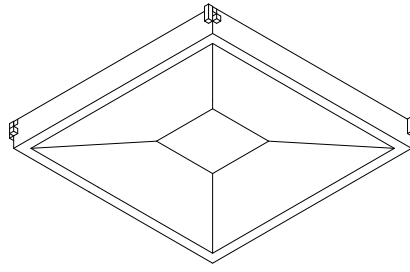

VEDI DIMENSIONS (NOMINAL)
WEIGHT: 3 LBS

VOI DIMENSIONS (NOMINAL)
WEIGHT: 3.3 LBS

ASSEMBLY & INSTALLATION

FOLD TILES , CONNECT CORNER TABS AND PLACE IN T-GRID

24" x 24" (NOMINAL) METTERE TILES

METTERE TILES CANNOT BE FIELD CUT NOR MODIFIED

FOR LOCATIONS SMALLER THAN STANDARD 24" x 24" METTERE TILES, SPECIFY MUTO SLAB PANELS IN THE SAME SPECIFIED COLOR

METTERE TILES CAN BE CUT FOR LIGHTING. CUTTING FOR LIGHTING IS PERFORMED IN FIELD. SOELBERG DOES NOT PROVIDE LIGHTING. ALL LIGHTING MUST BE ANCHORED TO THE DECK. METTERE TILES DO NOT SUPPORT LIGHTING WEIGHT NOR OTHER MEP COMPONENTS.

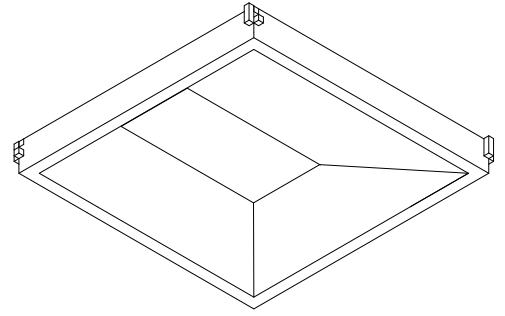

METTERE TILE DIMENSIONS 24" x 24" (NOMINAL)
WEIGHT: 2 LBS 13 OZ

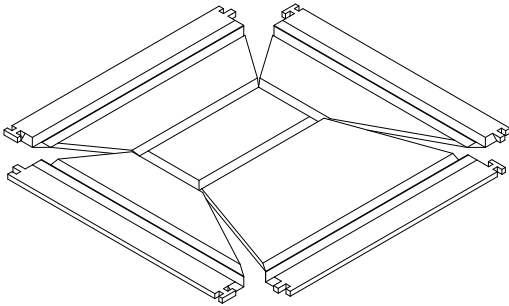

METTERE TILES SHIP FLAT

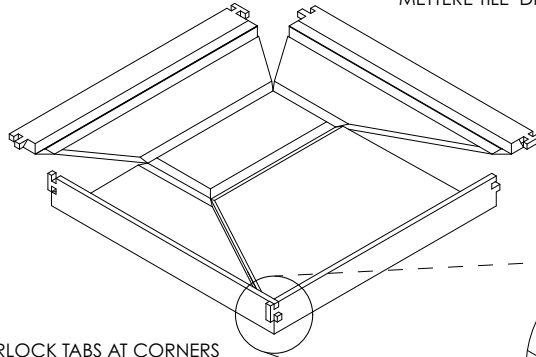

INTERLOCK TABS AT CORNERS

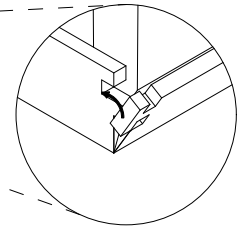

METTERE ASSEMBLY

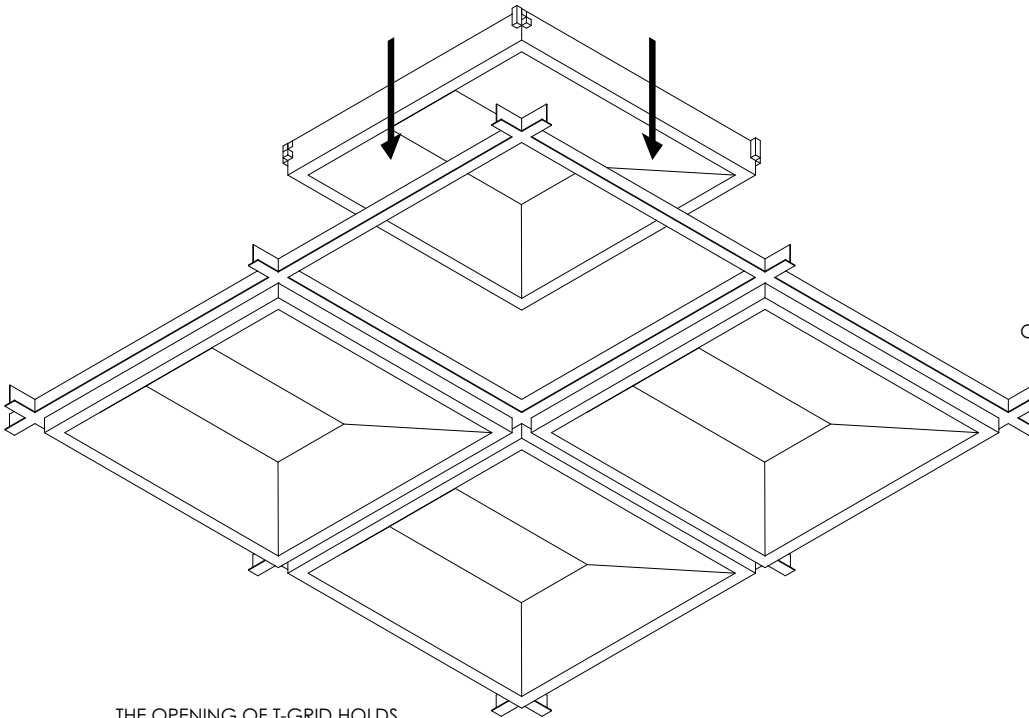

THE OPENING OF T-GRID HOLDS METTERE TILE SHAPE AND METTERE TABS AT CORNER REST ON T-GRID. 24" CLEARANCE ABOVE GRID IS REQUIRED TO INSTALL METTERE TILES.

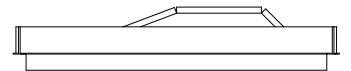

ANGLE TILES TO PASS THRU T-GRID OPENING AND THEN POSITION IN 15/16" T-GRID

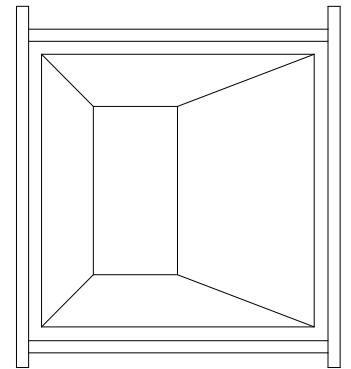

METTERE INSTALLATION (15/16" T-GRID)

INSTALLATION CONTINUED

METTERE TILES SIZING CANNOT BE FIELD MODIFIED

ORDER SLAB PANELS IN THE SPECIFIED COLOR TO BE FILED TRIMMED FOR ALL IRREGULAR T-GRID CELLS.

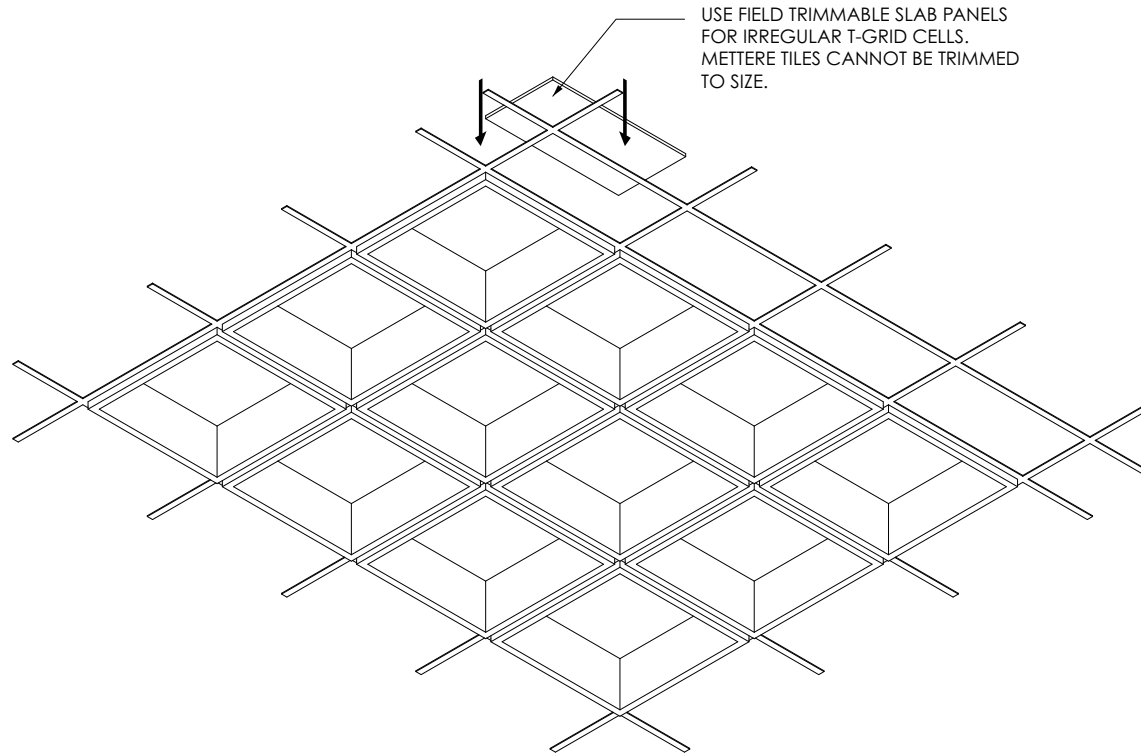

TRIMMING FOR LIGHTING

METTERE TILES CANNOT BE FILED TRIMMED TO FIT A CUSTOM SIZE GRID OPENING.

FIELD TRIMMING FOR LIGHTING AND FIXTURES MAY BE DONE IN FIELD AS LONG AS CUTS ARE 1" FROM FOLD LOCATIONS.

ALL LIGHTS AND FIXTURES MUST BE INDEPENDENTLY SUPPORTED. METTERE TILES DO NOT SUPPORT THE WEIGHT OF MEP COMPONENTS.

FOR IRREGULAR GRID SIZES AROUND THE EDGE OR NON-SQUARE GRID OPENINGS, USE FIELD TRIMMABLE SLAB PANELS TO FILL.

TILE EXAMPLE

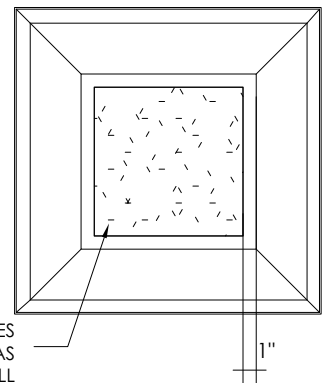

TRIMMING FOR LIGHTS AND FIXTURES MAY BE DONE IN FIELD AS LONG AS CUTS ARE AT LEAST 1" CLEAR OF ALL FOLD LOCATIONS.

PATTERN INSPIRATION

UNLIMITED PATTERN OPTIONS

SINGLE TILE PATTERNS
ROTATE PROFILES 90°, 180° OR 270°

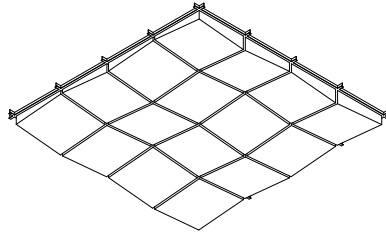

PATTERN IDEA 01
MENTIRE - QTY 16

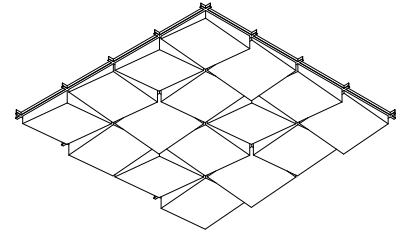

PATTERN IDEA 02
MENTIRE - QTY 16

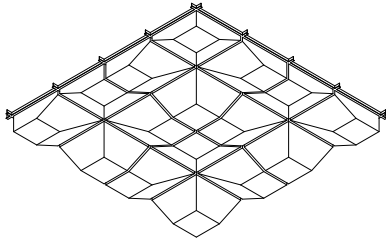

PATTERN IDEA 03
NOI - QTY 16

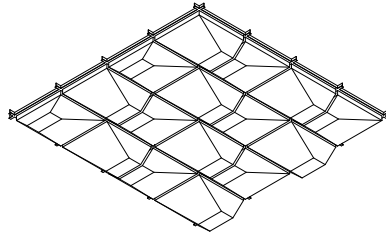

PATTERN IDEA 04
VOI - QTY 16

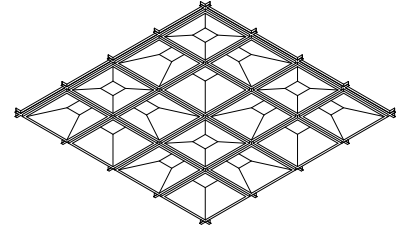

PATTERN IDEA 05
VEDI - QTY 16

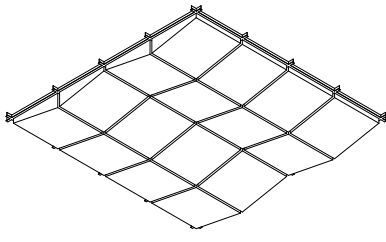

PATTERN IDEA 06
ERA - QTY 16

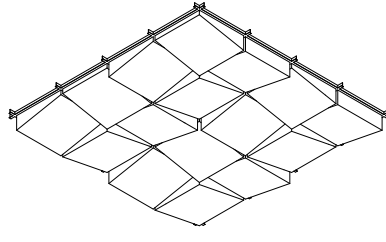

PATTERN IDEA 07
ERA - QTY 16

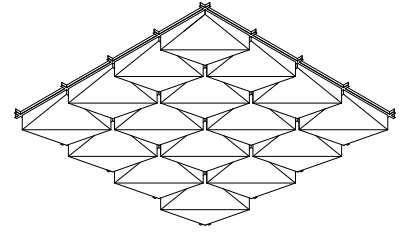

PATTERN IDEA 08
SUD - QTY 16

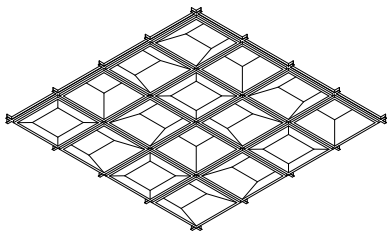

PATTERN IDEA 09
TOCCHI - QTY 16

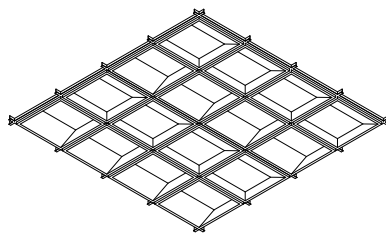

PATTERN IDEA 10
SENTI - QTY 16

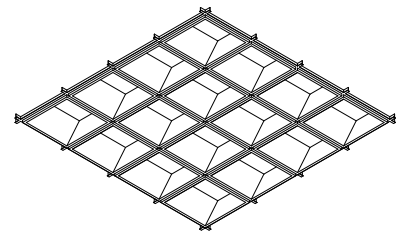

PATTERN IDEA 11
SOLLEVI - QTY 16

PATTERN INSPIRATION CONTINUED

UNLIMITED PATTERN OPTIONS

MIX AND MATCH TILE PROFILES
ROTATE PROFILES 90°, 180° OR 270°

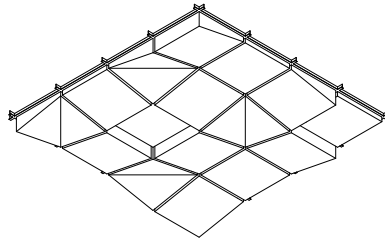

PATTERN IDEA 12

UNO - QTY 4
NORD - QTY 4
ERA - QTY 8

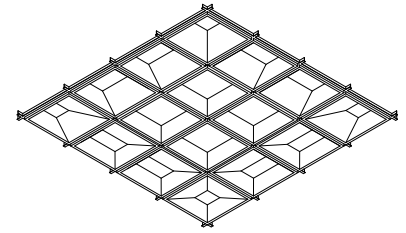

PATTERN IDEA 13

CASSONE - QTY 4
SAI - QTY 8
VEDI - QTY 4

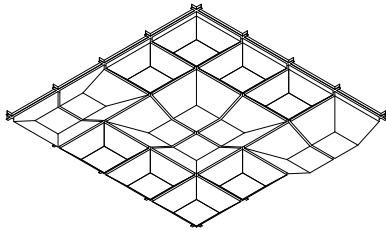

PATTERN IDEA 14

QUI - QTY 8
NOI - QTY 8

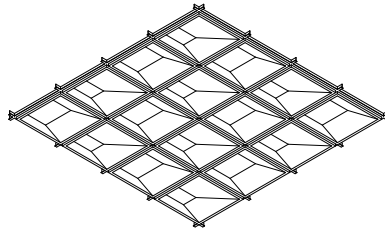

PATTERN IDEA 15

TOCCHI - QTY 8
SOLLEVI - QTY 8

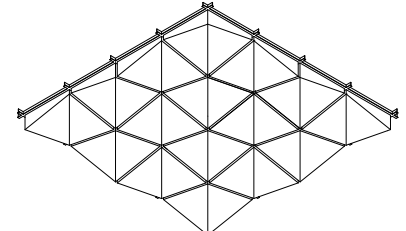

PATTERN IDEA 16

NORD - QTY 8
SUD - QTY 8

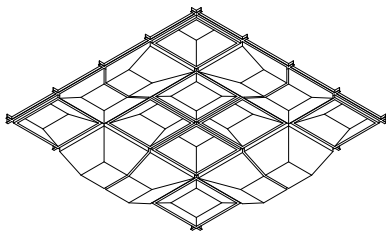

PATTERN IDEA 17

TOCCHI - QTY 8
NOI - QTY 8

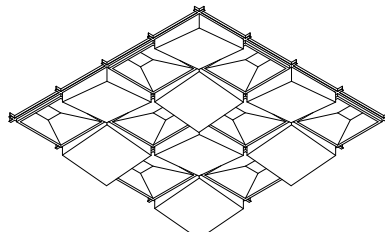

PATTERN IDEA 18

MENTIRE - QTY 8
VEDI - QTY 8

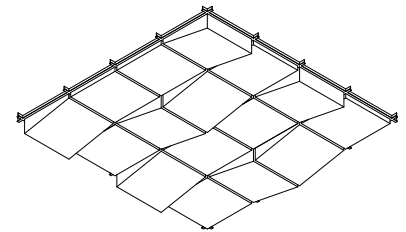

PATTERN IDEA 19

ERA - QTY 8
UNO - QTY 8

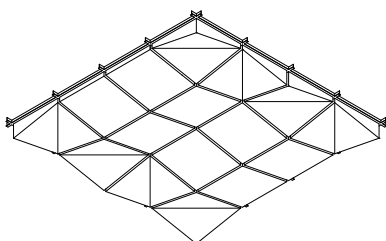

PATTERN IDEA 20

ERA - QTY 8
NORD - QTY 8

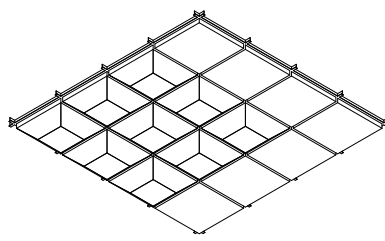

PATTERN IDEA 21

UNO - QTY 7
QUI - QTY 9

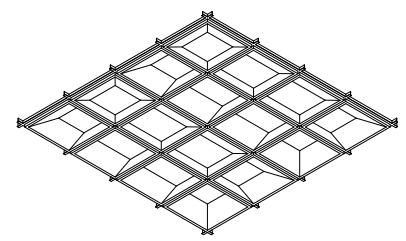

PATTERN IDEA 22

TOCCHI - QTY 8
SENTI - QTY 8

ENVIRONMENTAL

DECLARE, MINDFUL MATERIALS & GREENGUARD GOLD CERTIFIED

We care about the environment and it matters that our materials support healthy and productive interior spaces. We use innovative materials but ensure that they meet the highest level of standards and expectations.

MUTO PET felt core material is 100% recyclable with no added urea formaldehyde with a minimum of 60% pre-consumer recycled content. MUTO is Declare, Mindful Materials and GreenGuard Gold certified.

Declare.

