

# MUTO FORMA

acoustic wall tile solutions

---

 SOELBERG



# MUTO FORMA

acoustic wall tile solutions

Geometric acoustic wall art for incredibly productive spaces. MUTO Forma acoustic wall tiles make it easy to create quiet patterning. Choose from 8 shapes that interact together in a combination of 21 colorways for seemingly limitless wall pattern layouts. Simple specification and quick lead time make Forma your immediate sound softening solution.

Make It Cool. Make It Quiet.

## SPECIFICATION

<b>CONTENT</b>	100% POLYESTER (PET) FELT	
<b>CORE THICKNESS</b>	1/2" (12MM) FELT	
<b>SHAPES</b>	DIAMOND 01 HEXAGON 02 RECTANGLE 01 SQUARE 01	HEXAGON 01 PENTAGON 01 RECTANGLE 02 TRIANGLE 01
<b>COLORWAYS</b>	27 COLORWAYS	
<b>TILE SIZE</b>	VARIOUS (SEE DIMENSIONS)	
<b>EDGE DETAIL</b>	1/4" CHAMFER PERIMETER CUT	
<b>WEIGHT</b>	1/2 LB   SQUARE FOOT	
<b>ACOUSTICS</b>	0.40 NRC	
<b>FIRE RATING</b>	CLASS A   ASTM - E84	
<b>ENVIRONMENTAL</b>	DELICARE, MINDFUL MATERIALS & GREENGUARD GOLD CERTIFIED. MUTO IS PRODUCED FROM 100% RECYCLABLE PET FELT WITH A MINIMUM OF 60% PRE-CONSUMER RECYCLED CONTENT.	
<b>LEAD TIME</b>	2 - 3 WEEKS	
<b>WARRANTY</b>	2 YEARS	

## TOLERANCE

PET core is a soft fibrous material. All dimensions and squareness are subject to +/- 1/16" tolerance.

## MAINTENANCE

Vacuum to remove dirt and dust. Remove spills or spots immediately using a clean damp cloth. Carpet and fabric cleaners can also be used to clean. (Always test an inconspicuous area first.) Compressed air may be used to dust in difficult or hard-to-reach areas.

To disinfect, bleach can be used in accordance with CDC Cleaning & Disinfection instructions. The solution ratio is 5 tablespoons of bleach to 1 gallon of water | 4 teaspoons of bleach to 1 quart of water. Apply solution by spray and wipe off immediately. (Always test in an inconspicuous area first.)



# SHAPES

## 8 STANDARD TILE SHAPES

1/2" CORE THICKNESS

1/4" CHAMFER PERIMETER EDGE DETAIL



FORMA DIAMOND 01

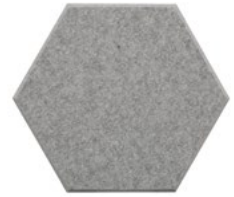

FORMA HEXAGON 01



FORMA HEXAGON 02



FORMA PENTAGON 01



FORMA RECTANGLE 01



FORMA RECTANGLE 02

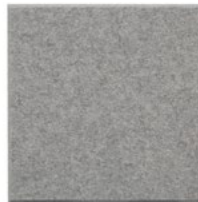

FORMA SQUARE 01

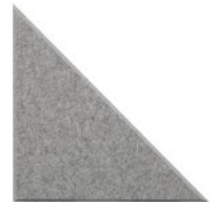

FORMA TRIANGLE 01



# PATTERN IDEAS

## LIMITLESS TILE LAYOUT OPTIONS

8 STANDARD TILE PATTERN SHAPES

21 STANDARD COLORWAYS

CUSTOM SHAPES & COLORS CONTACT YOUR LOCAL REP FOR MORE DETAILS.

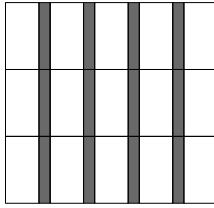

**PATTERN 1**  
RECTANGLE 01 - QTY 15  
RECTANGLE 02 - QTY 12

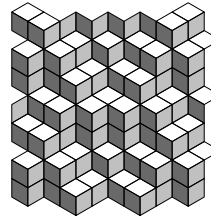

**PATTERN 2**  
DIAMOND 01 - QTY 42  
DIAMOND 01 - QTY 42  
DIAMOND 01 - QTY 40

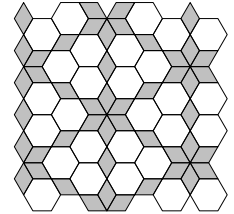

**PATTERN 3**  
HEXAGON 01 - QTY 28  
DIAMOND 01 - QTY 48

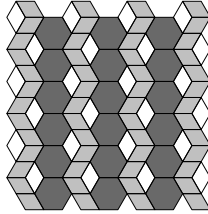

**PATTERN 4**  
HEXAGON 01 - QTY 18  
DIAMOND 01 - QTY 24  
DIAMOND 01 - QTY 52

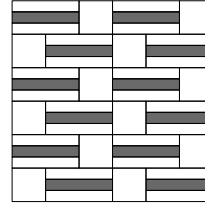

**PATTERN 5**  
RECTANGLE 02 - QTY 12  
RECTANGLE 02 - QTY 24  
SQUARE 01 - QTY 12

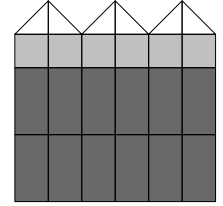

**PATTERN 6**  
TRIANGLE 01 - QTY 6  
SQUARE 01 - QTY 6  
RECTANGLE 01 - QTY 12

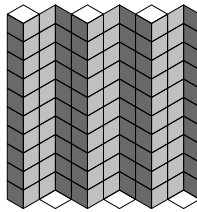

**PATTERN 7**  
DIAMOND 01 - QTY 6  
DIAMOND 01 - QTY 60  
DIAMOND 01 - QTY 60

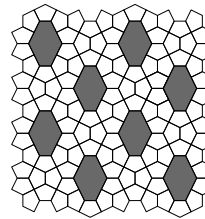

**PATTERN 8**  
HEXAGON 02 - QTY 8  
PENTAGON 01 - QTY 118

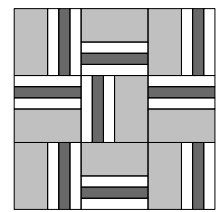

**PATTERN 9**  
RECTANGLE 01 - QTY 9  
RECTANGLE 02 - QTY 9  
RECTANGLE 02 - QTY 18

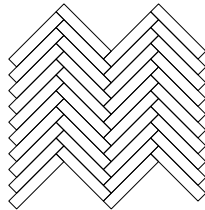

**PATTERN 10**  
RECTANGLE 02 - QTY 40

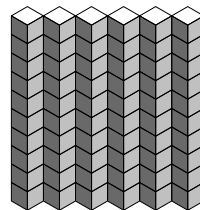

**PATTERN 11**  
DIAMOND 01 - QTY 6  
DIAMOND 01 - QTY 60  
DIAMOND 01 - QTY 60

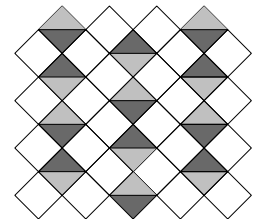

**PATTERN 12**  
TRIANGLE 01 - QTY 12  
TRIANGLE 01 - QTY 12  
SQUARE 01 - QTY 24

# PATTERN IDEAS CONTINUED

## LIMITLESS TILE LAYOUT OPTIONS

8 STANDARD TILE PATTERN SHAPES

21 STANDARD COLORWAYS

CUSTOM SHAPES & COLORS CONTACT YOUR LOCAL REP FOR MORE DETAILS.

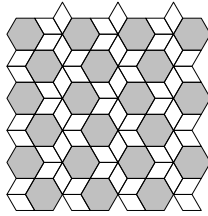

**PATTERN 13**  
HEXAGON 01 - QTY 21  
DIAMOND 01 - QTY 60

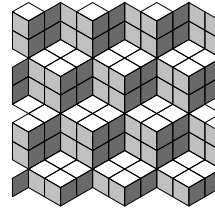

**PATTERN 14**  
DIAMOND 01 - QTY 39  
DIAMOND 01 - QTY 46  
DIAMOND 01 - QTY 45

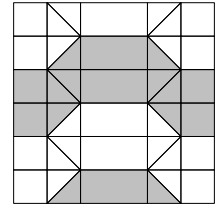

**PATTERN 15**  
SQUARE 01 - QTY 8  
RECTANGLE 01 - QTY 3  
TRIANGLE 01 - QTY 14  
SQUARE 01 - QTY 4  
RECTANGLE 01 - QTY 3  
TRIANGLE 01 - QTY 10

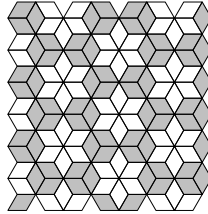

**PATTERN 16**  
DIAMOND 01 - QTY 69  
DIAMOND 01 - QTY 64

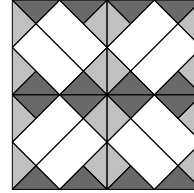

**PATTERN 17**  
TRIANGLE 01 - QTY 16  
TRIANGLE 01 - QTY 16  
RECTANGLE 01 - QTY 8

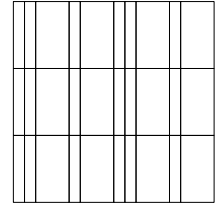

**PATTERN 18**  
RECTANGLE 01 - QTY 12  
RECTANGLE 02 - QTY 18

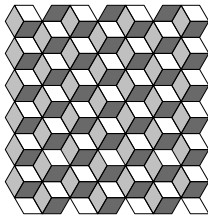

**PATTERN 19**  
DIAMOND 01 - QTY 41  
DIAMOND 01 - QTY 44  
DIAMOND 01 - QTY 46

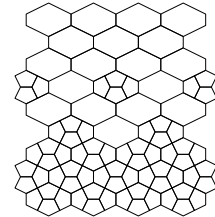

**PATTERN 20**  
HEXAGON 02 - QTY 18  
PENTAGON 01 - QTY 68

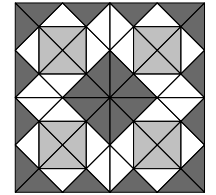

**PATTERN 21**  
TRIANGLE 01 - QTY 16  
TRIANGLE 01 - QTY 24  
TRIANGLE 01 - QTY 24

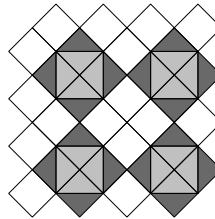

**PATTERN 22**  
SQUARE 01 - QTY 16  
TRIANGLE 01 - QTY 16  
TRIANGLE 01 - QTY 16

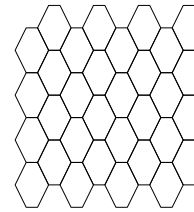

**PATTERN 23**  
HEXAGON 01 - QTY 32

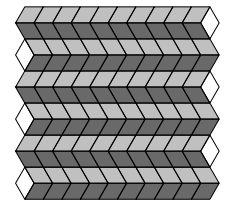

**PATTERN 24**  
DIAMOND 01 - QTY 6  
DIAMOND 01 - QTY 60  
DIAMOND 01 - QTY 60

# DIMENSIONS

## 8 STANDARD TILE PATTERNS

SHAPES INTERACT FOR MORE PATTERNING

Three Diamond 01 tiles equal the size of one Hexagon 01 tile.

Four Pentagon 01 tiles equal the size of one Hexagon 02 tile.

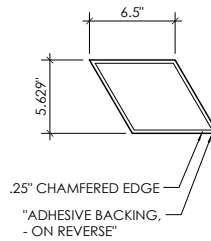

FORMA DIAMOND 01 - FACE

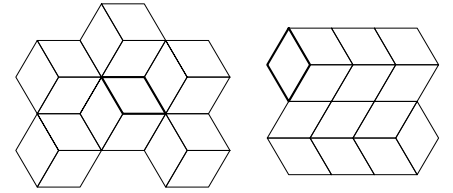

FORMA DIAMOND 01 - TILED

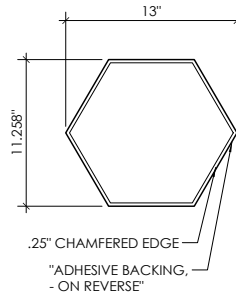

FORMA HEXAGON 01 - FACE

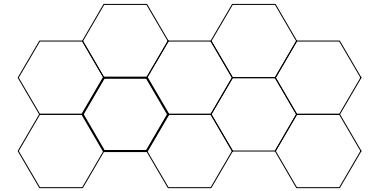

FORMA HEXAGON 01 - TILED

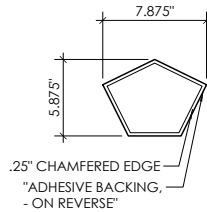

FORMA PENTAGON 01 - FACE

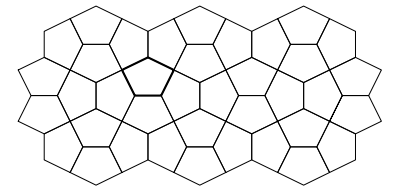

FORMA PENTAGON 01 - TILED

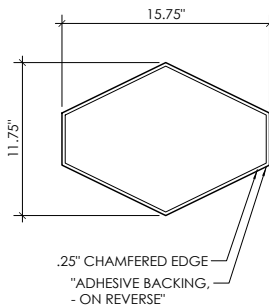

FORMA HEXAGON 02 - FACE

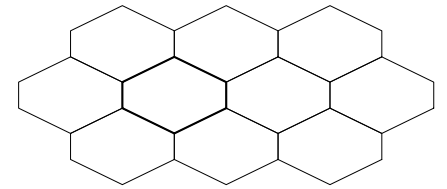

FORMA HEXAGON 02 - TILED

# DIMENSIONS CONTINUED

## 8 STANDARD TILE PATTERNS

SHAPES INTERACT FOR MORE PATTERN

Three Rectangle 02 tiles equal the size of one Rectangle 01 tile.

Two Square 01 tiles equal the size of one Square 01 tile.

Two Triangle 01 tiles equal the size of one Square 01 tile.

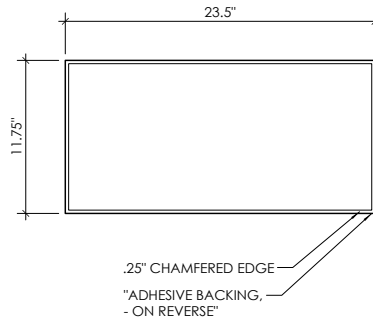

FORMA RECTANGLE 01 - FACE

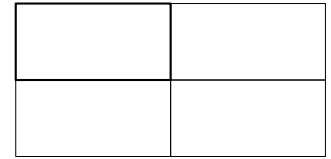

FORMA RECTANGLE 01 - TILED

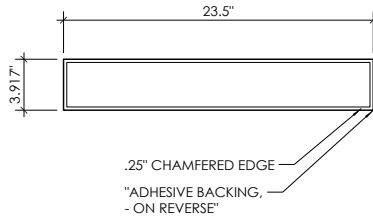

FORMA RECTANGLE 02 - FACE

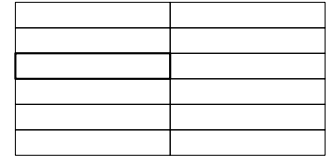

FORMA RECTANGLE 02 - TILED

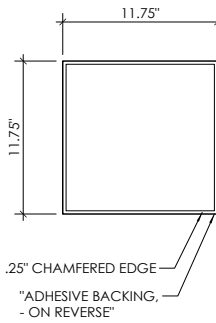

FORMA SQUARE 01 - FACE

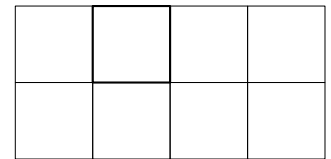

FORMA SQUARE 01 - TILED

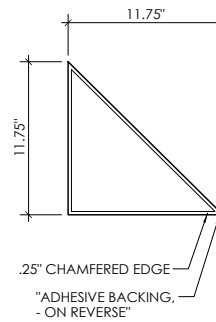

FORMA TRIANGLE 01 - FACE

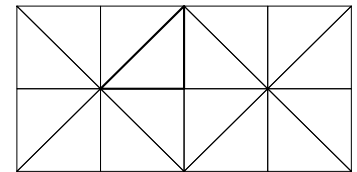

FORMA TRIANGLE 01 - TILED

# COLOR

## MATTE COLOR

27 STANDARD COLORS  
CUSTOM PRINT COLORS AVAILABLE  
(CONTACT YOUR LOCAL SALES REP)  
100% RECYCLABLE PET FELT

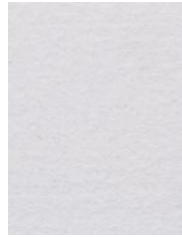

WHITE

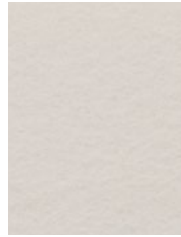

BONE

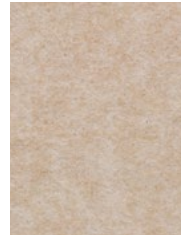

OATMEAL

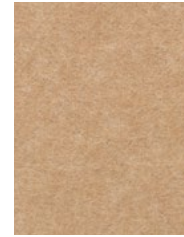

CAMEL



SAND

## TOLERANCES

PET felt is made from 100% recyclable polyester plastic. Variation in depth will occur. Slight and consistent variations in color, density, texture are inherent to this core material and should be expected. Color, density and texture will vary by dye lot. MUTO is made with a 'felling' process which results in a textural heathered effect where the fibers consist of multiple tones and shades.



CASHMERE



FOG

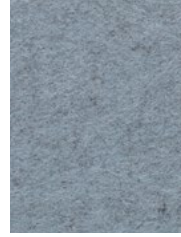

LAMB'S EAR

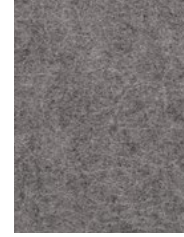

PEWTER



NORDIC KNIT

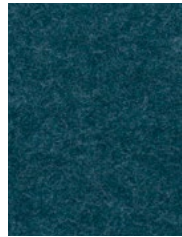

WINTER WATER

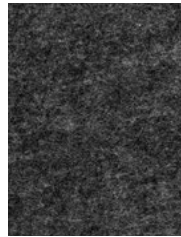

GRAPHITE



BLACK



MIDNIGHT



BLUEBERRY



JUNIPER



SPLASH



STORM

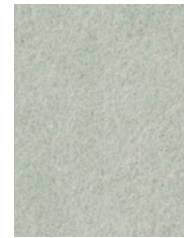

SEAFOAM



SAGE



ARTICHOKE

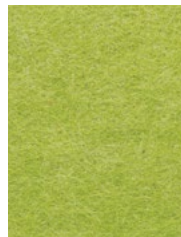

LICHEN

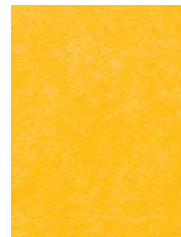

SUNSHINE



QUAKING ASPEN



CLEMENTINE

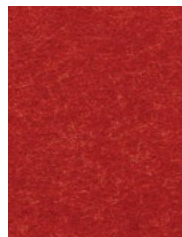

CHILI PEPPER



CURRANT



# ACOUSTICS

## NRC TEST DATA

Higher NRC ratings mean higher sound absorbency. The performance of 1/2" MUTO PET felt core material increases as the depth of air gap increases.

NRC values will vary based on customization and specific installation details. Contact your sales representative to learn more.

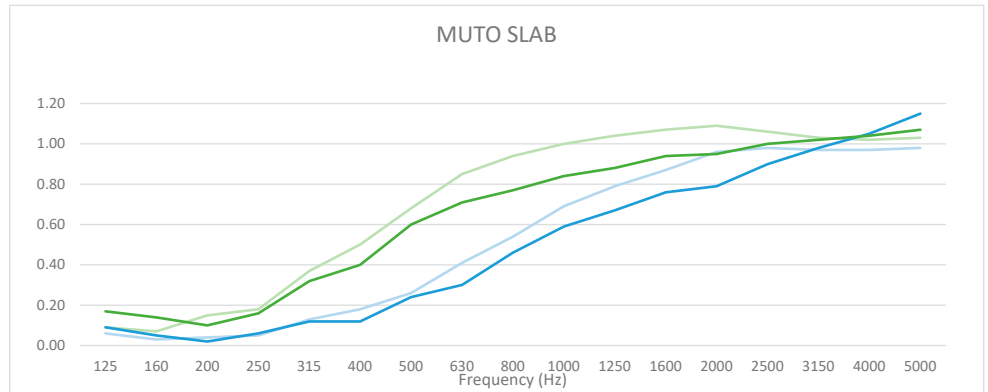

PRODUCT	MOUNTING	SAMPLE FREQUENCY (Hz)				NRC
		250	500	1000	2000	
1/2" MUTO	DIRECT	0.06	0.24	0.59	0.79	0.40
	Z-CLIP	0.05	0.26	0.69	0.96	
1" MUTO	DIRECT	0.16	0.60	0.84	0.95	0.65
	Z-CLIP	0.18	0.68	1.00	1.09	

\*\*\*NRC values are from Slab panels. MUTO Forma tiles have slightly lower values due to smaller scale. The more wall tiles covering the wall surface the higher the NRC values.

# ENVIRONMENTAL

## DECLARE, MINDFUL MATERIALS & GREENGUARD GOLD CERTIFIED

We care about the environment and it matters that our materials support healthy and productive interior spaces. We use innovative materials but ensure that they meet the highest level of standards and expectations.

MUTO PET felt core material is 100% recyclable with no added urea formaldehyde.



# INSTALLATION

## ADHESIVE BACKING

Forma files can be installed with our manufacturer-applied 3M peel and stick adhesive backing. Simply peel the contact paper from the adhesive and with pressure, apply to a clean, dust and debris free wall surface.

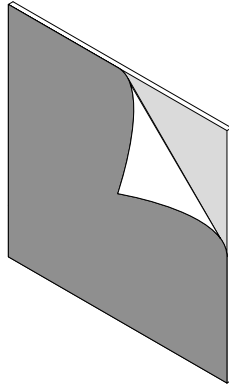

## CONSTRUCTION ADHESIVE

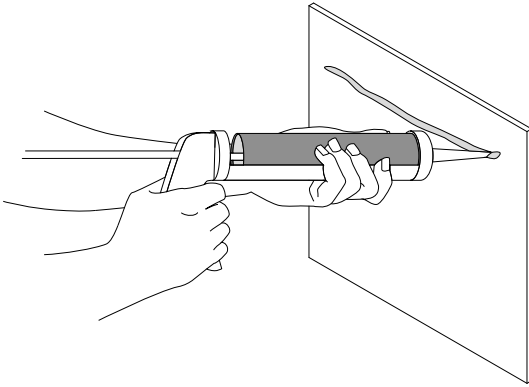

Forma files can also be installed using construction-grade adhesive supplied by the contractor. Please consult a licensed professional and follow all building codes.

