

# GEO TILES

3D wall tiles

---

 SOELBERG

# GEO TILES

## 3D wall tiles

Inspired by modern simplicity, the love of clean lines and the versatility of texture, GEO Tiles come together to create movement and motion in geometric form. Each tile can be finished in any of our beautiful 3D laminate colors or a variety of colors to create your very own combination. Rotate tiles to tailor and customize your very own wall story. A few tiles or many make an unforgettable 3D wall.

## SPECIFICATION

<b>CORE</b>	PREMIUM MDF OR FIRE RATED MDF	
<b>CORE THICKNESS</b>	3/4" - 1 3/8"	
<b>PATTERNS</b>	AEREO CASCO MURO SALITA	CADUTA CRESTA RICCIO VOLO
<b>FINISH</b>	35 - 3D LAMINATE COLORS PAINT GRADE   FIELD PAINTED	
<b>SIZE</b>	AEREO   9"x9" CASCO   22" x 22" MURO   18"x6" SALITA   22"x22"	CADUTA   22"x22" CRESTA   24"x8" RICCIO   22"x22" VOLO   22"x22"
<b>WEIGHT</b>	AEREO   2 lbs CASCO   7 lbs MURO   2 lbs SALITA   11 lbs	CADUTA   8 lbs CRESTA   4 lbs RICCIO   7 lbs VOLO   7 lbs
<b>FIRE RATING</b>	3/4" - 1 1/8" CLASS A   ASTM - E84 1 3/8" CLASS C	
<b>LEAD TIME</b>	2 WEEKS	
<b>WARRANTY</b>	5 YEARS	

## TOLERANCES

Geo Tiles are available in specific sizes to the pattern. All dimensions and squareness are subject to a 3/16" tolerance.

Each Geo Tile comes with a Melamine backer. Natural bow or warp is common to all wood products. Please compensate with proper installation techniques.

Geo Tiles, like all wood products, will expand and contract nominally with fluctuations in moisture levels. Wood products have a potential expansion of +/- 0.33%. Geo Tiles will grow in high humidity locations and shrink in low level humidity applications. Controlled environments with maintained humidity levels of 25 - 55% is recommended.

## MAINTENANCE

Geo Tiles should be dusted and cleaned occasionally to prevent dirt build-up. Stains should be removed with a warm diluted soap solution if necessary in combination with a non-abrasive cleaning sponge. Common cleaning products such as Windex, Simple Green, Fantastik, Formula 409 or 10:1 Water/Bleach solution are acceptable. After cleaning, the surface should be rinsed with clean water and dried with a soft non-abrasive cotton cloth. To test the suitability of a cleaning product, apply to an inconspicuous area to prevent any damage to the surface.

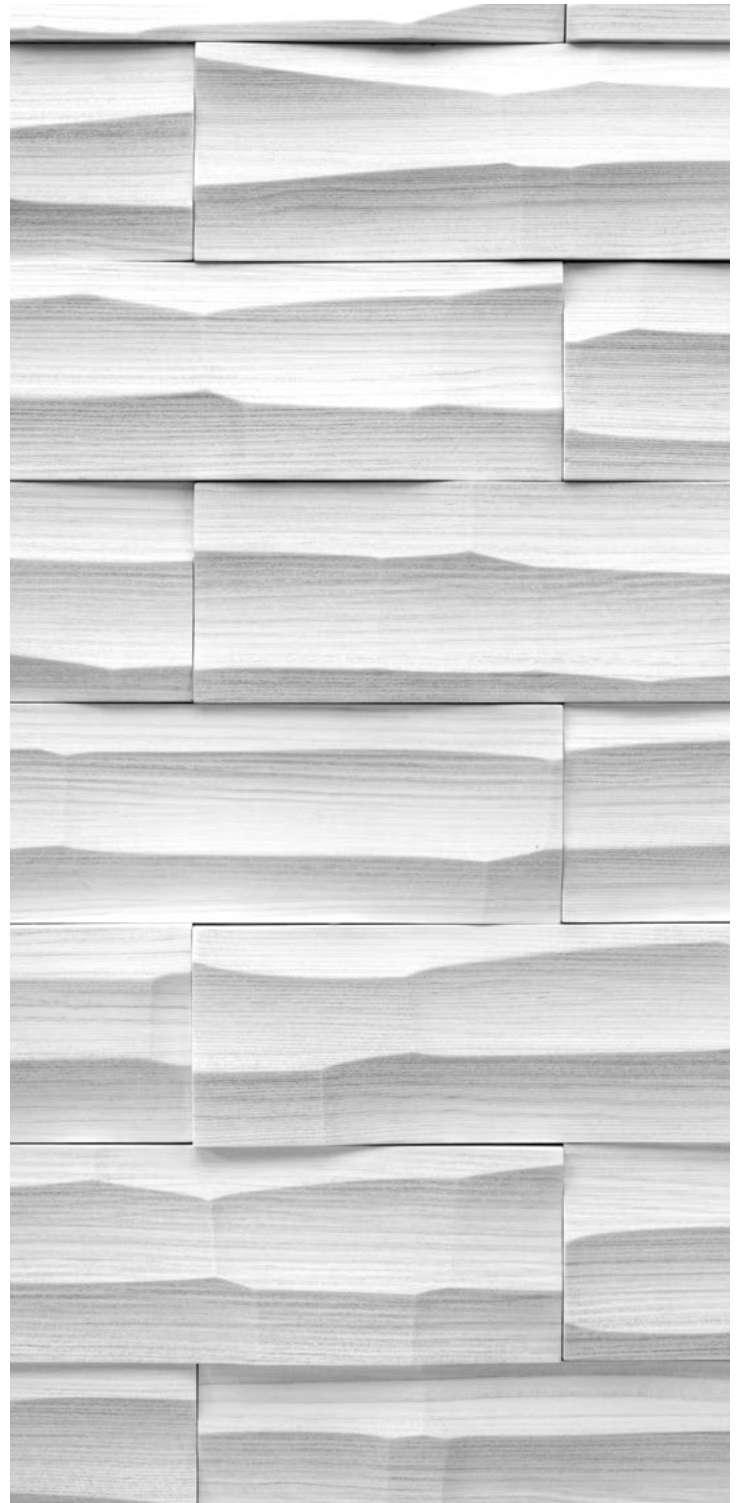

# GEO TILES

## 8 PATTERNS

### TEXTURE IN TILE FORM

DIMENSIONAL (SEE DRAWINGS)  
REPEATING FOR ENDLESS WALL TEXTURE

Each tile can be installed vertically or horizontally for continuous wall texture. Square tiles can be rotated 90°, 180° or 270° for unique and individual pattern continuation.

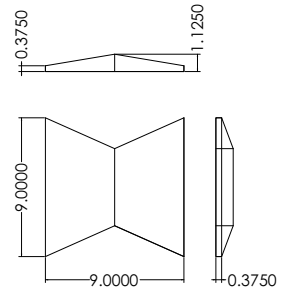

**AEREO**

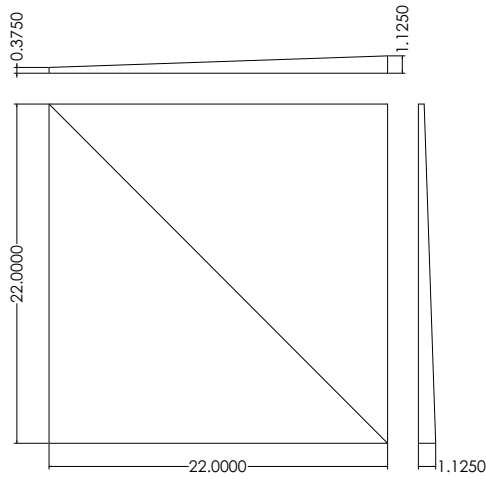

**CADUTA**

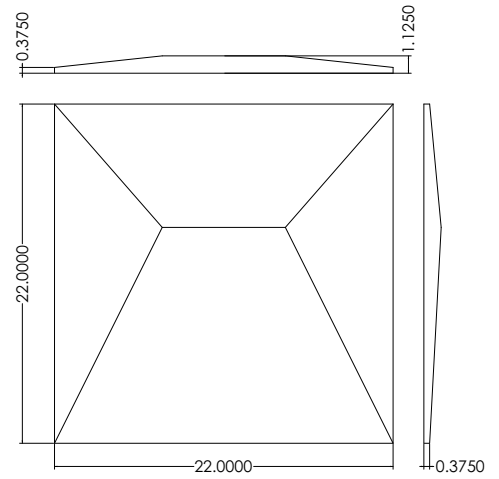

**CASCO**

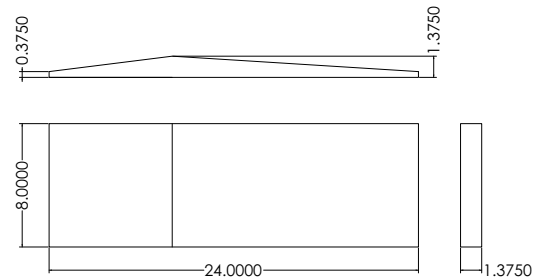

**CRESTA**

# PATTERNS CONTINUED

## TEXTURE IN TILE FORM

DIMENSIONAL (SEE DRAWINGS)  
REPEATING FOR ENDLESS WALL TEXTURE

Each tile can be installed vertically or horizontally for continuous wall texture. Square tiles can be rotated 90°, 180° or 270° for unique and individual pattern continuation.

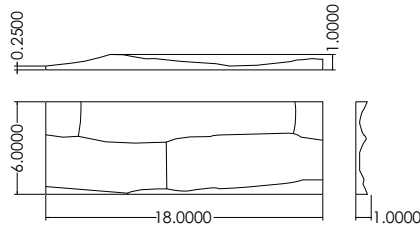

MURO

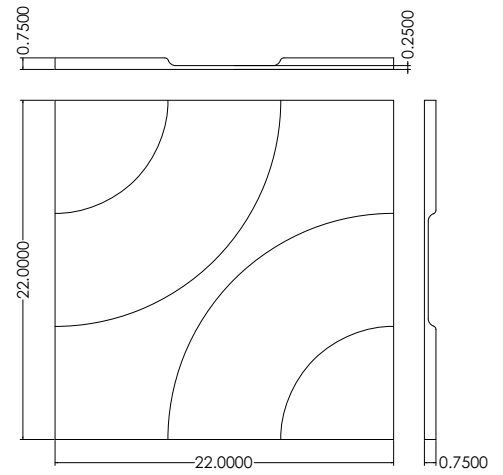

RICCIO

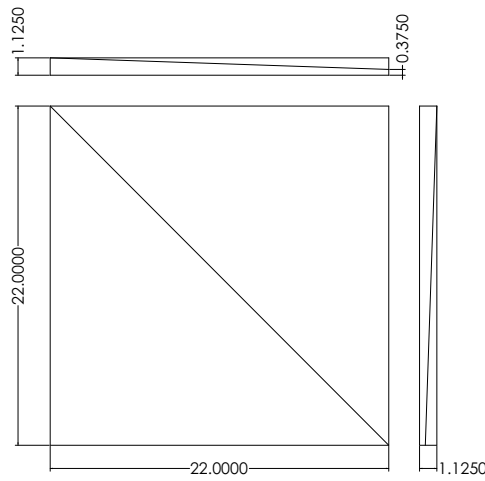

SALITA

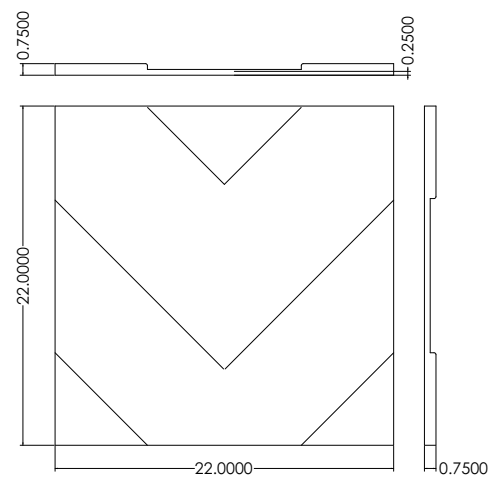

VOLO



# FINISH

## 3D LAMINATE

35 COLORS

SOLID | METALLIC | WOOD GRAIN | HIGH GLOSS  
MELAMINE BACKER

**3D laminate (rigid thermofoil or RTF) is a thermoformed decorative surface that is cleanable and durable. Please note: Delamination will occur when 3D laminated products are exposed to heat higher than 150°. Wood grain will always run parallel to the 96" length of the panel**

**3D Wall Panels can also be ordered unfinished to be painted in the field. Please contract a licensed professional and follow all local building codes and requirements.**

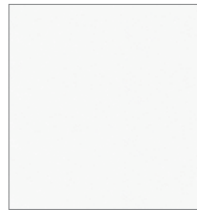

FROSTY WHITE

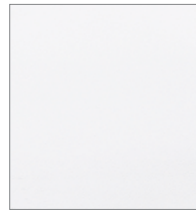

GLACIER WHITE



MATTE WHITE



WHITE HG



PORTUNA LIGHT



OAK ALABASTER

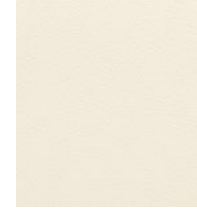

ANTIQUE WHITE



ALMOND

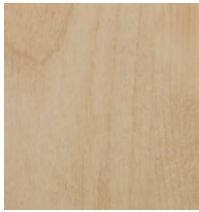

BLONDE MAPLE



CLEAR MAPLE

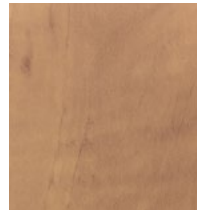

CANDLELIGHT



SALINAS OAK

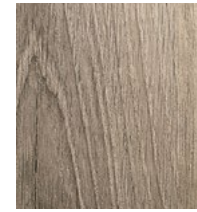

OAK PALOMINO

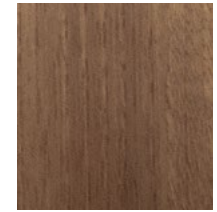

NATURAL WALNUT

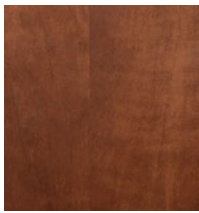

SUMMERFLAME

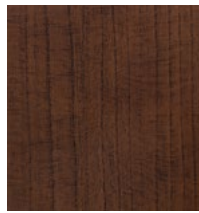

CHERRY BLOSSOM



AMATI WALNUT



OAK GIBRALTAR

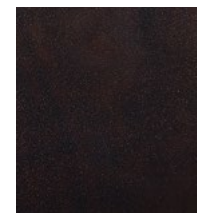

CHOCOLATE PEAR



PORTUNA DARK

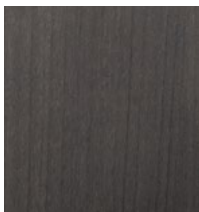

LAUSANNE



OAK ARGENTO

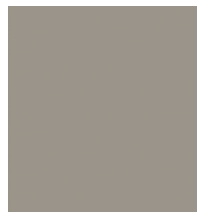

TURMALIN MATTE

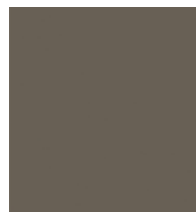

UMBRA MATTE



GAUNTLET GREY



SIENA MATTE



SHARK GREY



BLACK



BRUSHED STEEL HG



BRUSHED ALUMINUM



CADET



CELADON



CANADIAN GREY

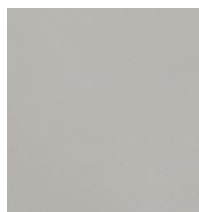

FASHION GREY

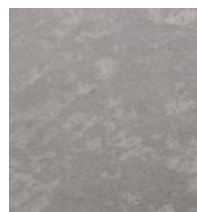

SAHARA STONE

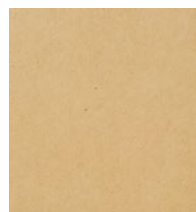

RAW MDF



## FINISH CONTINUED

### PAINT GRADE

RAW MDF TILES  
MELAMINE BACKER

Soelberg does not provide factory paint finished GEO Tiles. Field finishing should be performed by a licensed professional. Professional grade primer and paint are recommended using spray finish.

### COLOR CONSISTENCY

Paint Grade unfinished MDF GEO Tiles will not have consistent color from tile to tile as they are made using recycled | recovered wood products. It is not recommended to leave tiles unfinished or simply clear coat.

### STORAGE & HANDLING

GEO Tiles should be stored flat and in an HVAC controlled environment of 65 - 75° F (18 - 24° C) with relative humidity levels of 25 - 55% for at least 48 hours prior to installation. Installation areas must be enclosed and weatherproofed before installation commences.

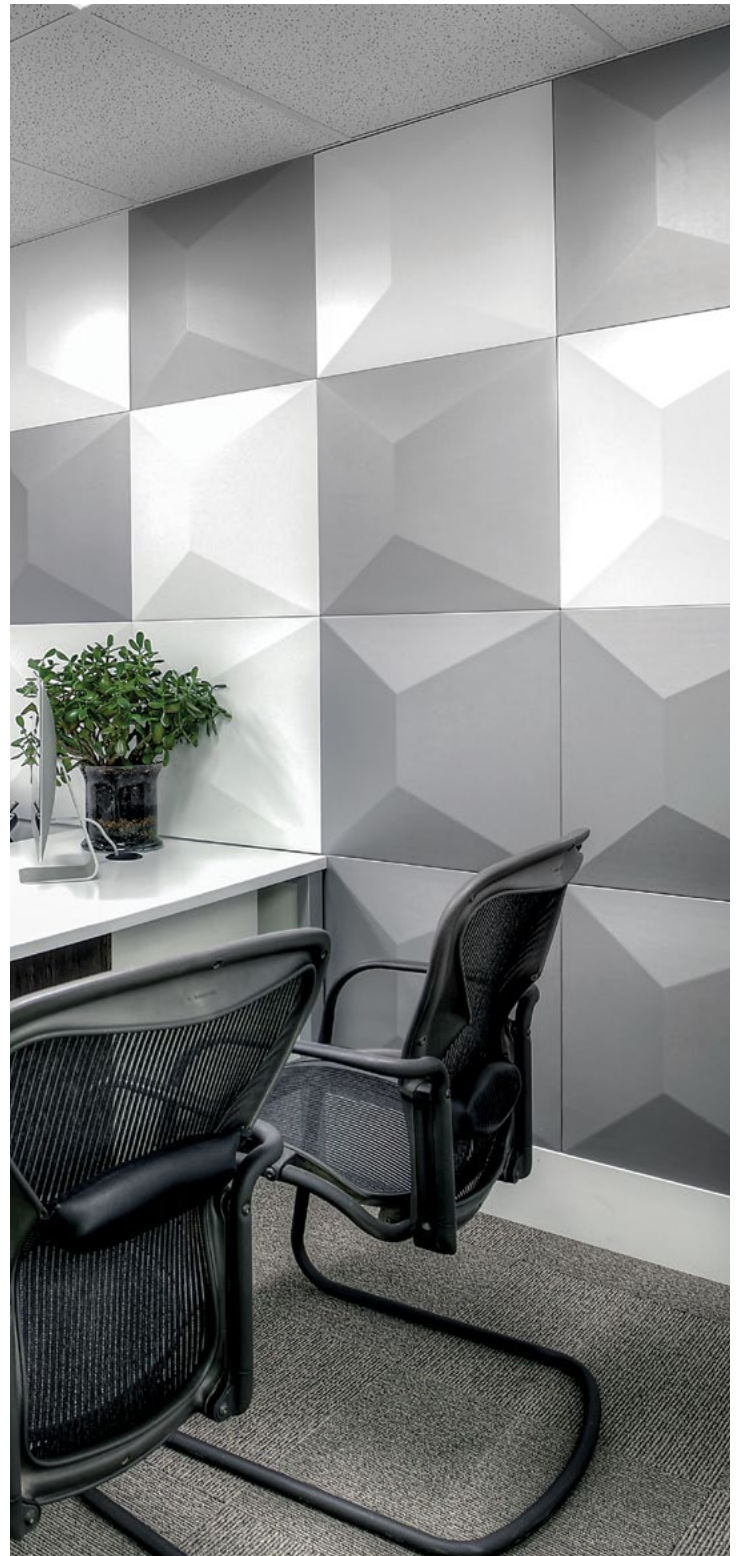

# INSTALLATION

## VHB TAPE OR ADHESIVE

GEO Tiles are installed one of two ways: Monolithically, placing each tile in the same direction repeated vertically or horizontally. Or, in Rotation, turning tiles 90°, 180° or 270° to create your own geometric repeat.

Tools required for installation include a level and measuring tape. Tiles can be installed by butt joint or with a reveal.

Clean the wall and tile surface making it free of dirt, oil and debris.

Using a level line and measuring tape, start installing tiles at the base of the design and work up installing towards the ceiling.

If using 3M VHB tape, remove paper backing from one side of the tile and apply tape with generous pressure around the perimeter of the back of the tile.

Remove paper backing from the 'wall side' of the tape and press tile firmly to the wall, applying pressure for 30-60 seconds.

If using industrial adhesive, bead around the perimeter of the back of the tile 1" from the edge. Support or structure may be needed to anchor tiles while adhesive cures. (VHB tape and adhesive can be used together for stronger adhesion.)

