

GEO TILES

3D wall tiles

 SOELBERG

GEO TILES

3D wall tiles

Inspired by modern simplicity, the love of clean lines and the versatility of texture, GEO Tiles come together to create movement and motion in geometric form. Each tile can be finished in any of our beautiful 3D laminate colors or a variety of colors to create your very own combination. Rotate tiles to tailor and customize your very own wall story. A few tiles or many make an unforgettable 3D wall.

SPECIFICATION

CORE	PREMIUM MDF OR FIRE RATED MDF	
CORE THICKNESS	3/4" - 1 3/8"	
PATTERNS	AEREO CASCO MURO SALITA	CADUTA CRESTA RICCIO VOLO
FINISH	38 - 3D LAMINATE COLORS PAINT GRADE FIELD PAINTED	
SIZE	AEREO 9"x9" CASCO 22" x 22" MURO 18"x6" SALITA 22"x22"	CADUTA 22"x22" CRESTA 24"x8" RICCIO 22"x22" VOLO 22"x22"
WEIGHT	AEREO 2 lbs CASCO 7 lbs MURO 2 lbs SALITA 11 lbs	CADUTA 8 lbs CRESTA 4 lbs RICCIO 7 lbs VOLO 7 lbs
FIRE RATING	3/4" - 1 1/8" CLASS A ASTM - E84 1 3/8" CLASS C	
LEAD TIME	2 WEEKS	
WARRANTY	5 YEARS	

TOLERANCES

Geo Tiles are available in specific sizes to the pattern. All dimensions and squareness are subject to a 3/16" tolerance.

Each Geo Tile comes with a Melamine backer. Natural bow or warp is common to all wood products. Please compensate with proper installation techniques.

Geo Tiles, like all wood products, will expand and contract nominally with fluctuations in moisture levels. Wood products have a potential expansion of +/- 0.33%. Geo Tiles will grow in high humidity locations and shrink in low level humidity applications. Controlled environments with maintained humidity levels of 25 - 55% is recommended.

MAINTENANCE

Geo Tiles should be dusted and cleaned occasionally to prevent dirt build-up. Stains should be removed with a warm diluted soap solution if necessary in combination with a non-abrasive cleaning sponge. Common cleaning products such as Windex, Simple Green, Fantastik, Formula 409 or 10:1 Water/Bleach solution are acceptable. After cleaning, the surface should be rinsed with clean water and dried with a soft non-abrasive cotton cloth. To test the suitability of a cleaning product, apply to an inconspicuous area to prevent any damage to the surface.

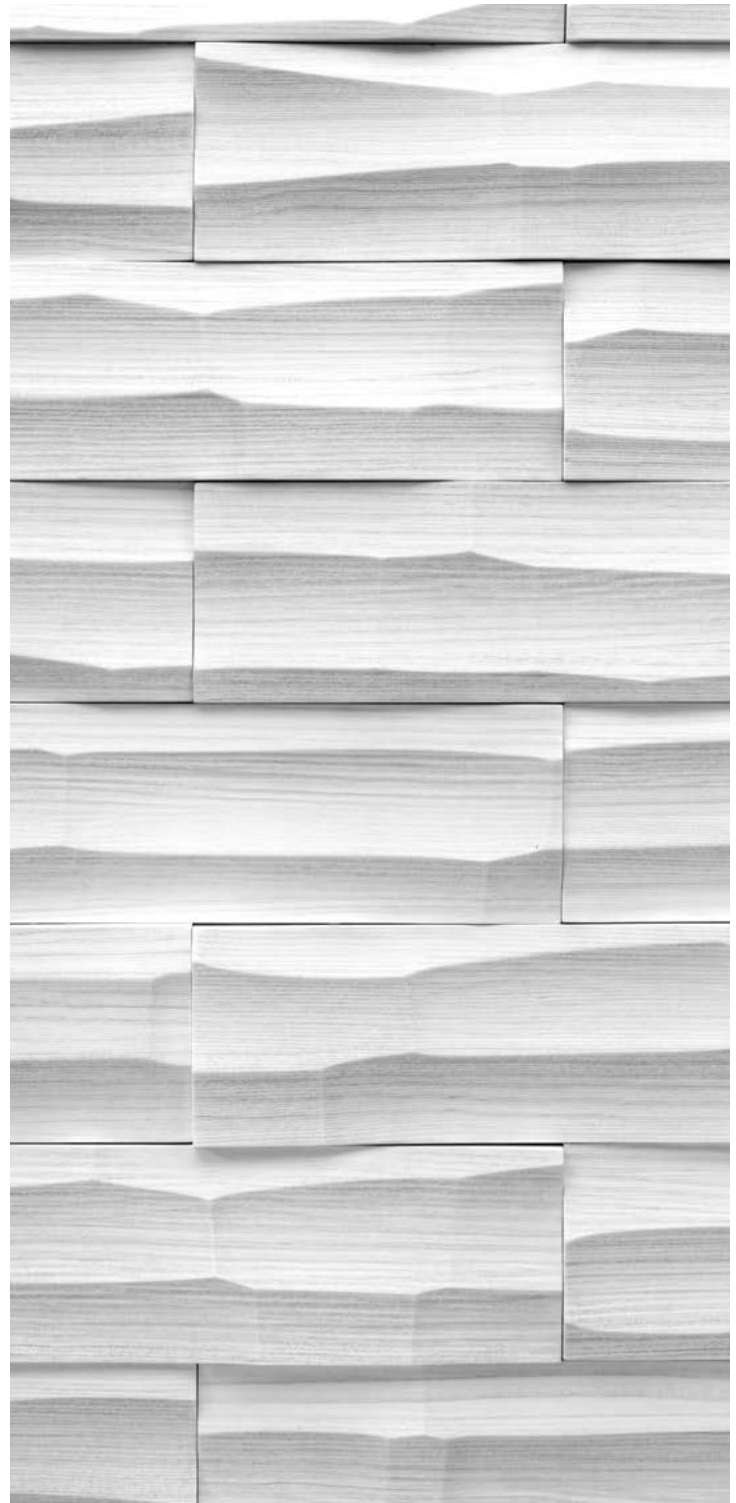

GEO TILES

8 PATTERNS

TEXTURE IN TILE FORM

DIMENSIONAL (SEE DRAWINGS)
REPEATING FOR ENDLESS WALL TEXTURE

Each tile can be installed vertically or horizontally for continuous wall texture. Square tiles can be rotated 90°, 180° or 270° for unique and individual pattern continuation.

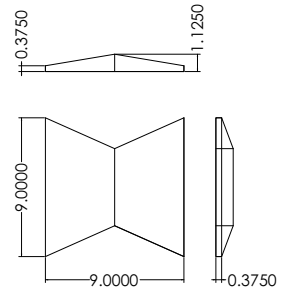

AEREO

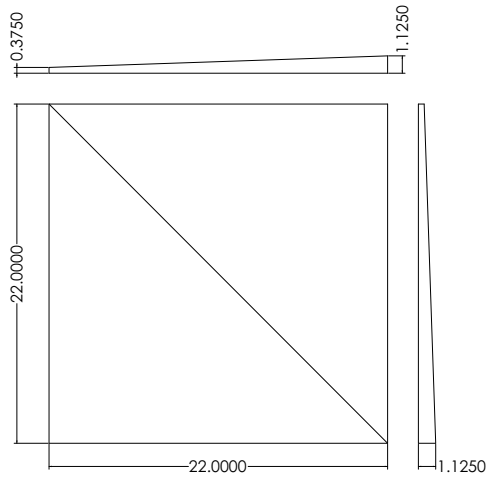

CADUTA

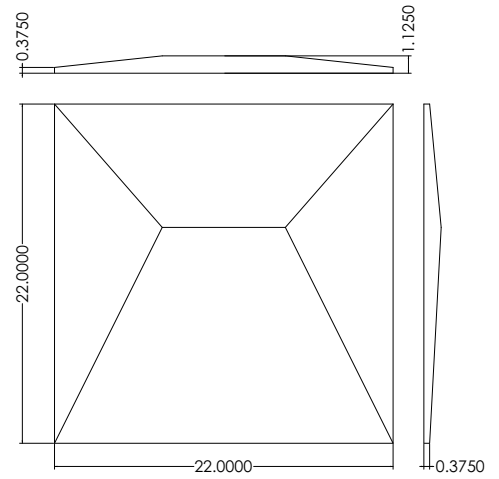

CASCO

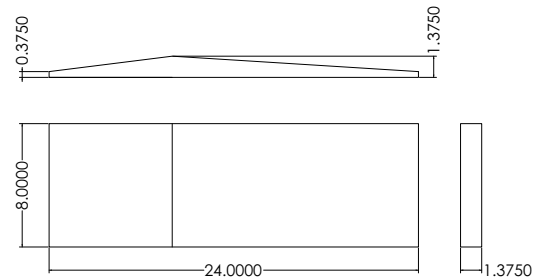

CRESTA

PATTERNS CONTINUED

TEXTURE IN TILE FORM

DIMENSIONAL (SEE DRAWINGS)
REPEATING FOR ENDLESS WALL TEXTURE

Each tile can be installed vertically or horizontally for continuous wall texture. Square tiles can be rotated 90°, 180° or 270° for unique and individual pattern continuation.

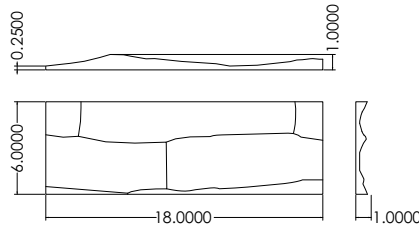

MURO

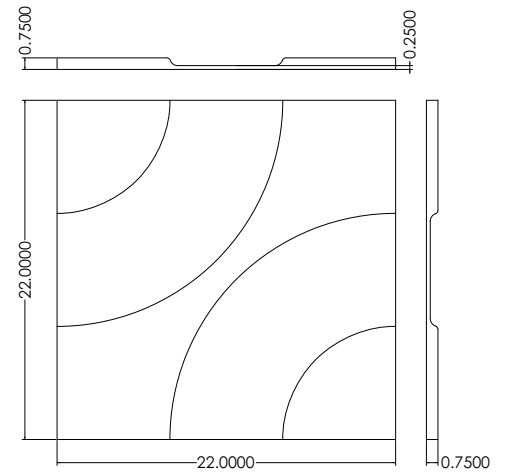

RICCIO

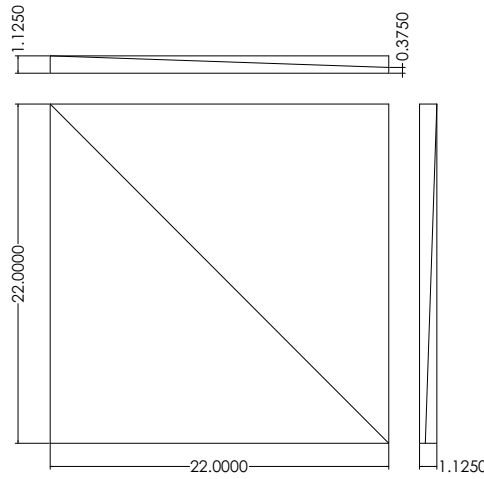

SALITA

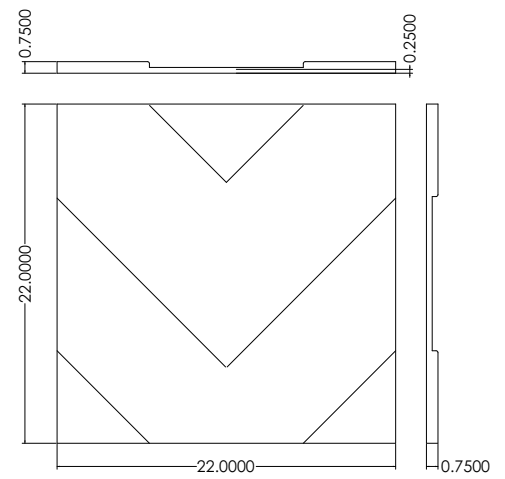

VOLO



FINISH

3D LAMINATE

38 COLORS

SOLID | METALLIC | WOOD GRAIN | HIGH GLOSS
MELAMINE BACKER

3D laminate (rigid thermofoil or RTF) is a thermoformed decorative surface that is cleanable and durable. Please note: Delamination will occur when 3D laminated products are exposed to heat higher than 150°.

Geo Tiles can also be ordered unfinished to be painted in the field. Please contract a licensed professional and follow all local building codes and requirements.

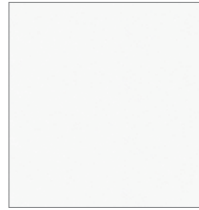

FROSTY WHITE

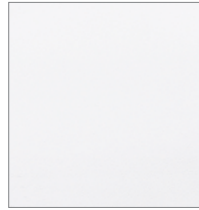

GLACIER WHITE

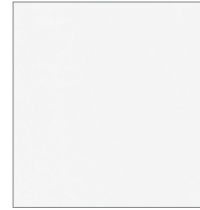

MATTE WHITE



WHITE HG



PORTUNA LIGHT



ANTIQUE WHITE

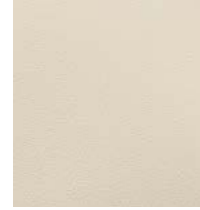

ALMOND



BLONDE MAPLE



CLEAR MAPLE



BIRDS EYE MATTE



CANDLELIGHT



OAK PALOMINO



NATURAL WALNUT



RUSTIC CHERRY



SUMMERFLAME



CHERRY BLOSSOM



JUBILEE CHERRY



AMATI WALNUT



OAK GIBRALTAR



OAK KODIAK



BOARDWALK



CHOCOLATE PEAR



WENGE



PORTUNA DARK



LAUSANNE



OAK ARGENTO

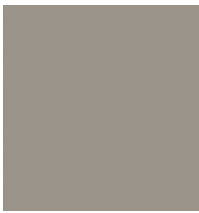

TURMALIN MATTE

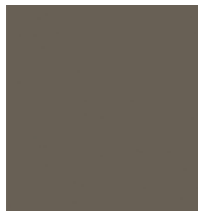

UMBRA MATTE

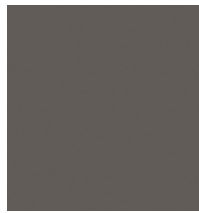

GAUNTLET GREY

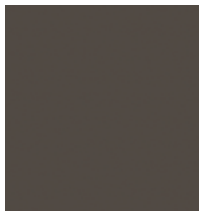

SIENA MATTE



FLAT IRON



SHARK GREY



BLACK



BLACK HG



BRUSHED STEEL HG



BRUSHED ALUMINUM



FASHION GREY

FINISH CONTINUED

PAINT GRADE

RAW MDF TILES
MELAMINE BACKER

Soelberg does not provide factory paint finished GEO Tiles. Field finishing should be performed by a licensed professional. Professional grade primer and paint are recommended using spray finish.

COLOR CONSISTENCY

Paint Grade unfinished MDF GEO Tiles will not have consistent color from tile to tile as they are made using recycled | recovered wood products. It is not recommended to leave tiles unfinished or simply clear coat.

STORAGE & HANDLING

GEO Tiles should be stored flat and in an HVAC controlled environment of 65 - 75° F (18 - 24° C) with relative humidity levels of 25 - 55% for at least 48 hours prior to installation. Installation areas must be enclosed and weatherproofed before installation commences.



INSTALLATION

VHB TAPE OR ADHESIVE

GEO Tiles are installed one of two ways: Monolithically, placing each tile in the same direction repeated vertically or horizontally. Or, in Rotation, turning tiles 90°, 180° or 270° to create your own geometric repeat.

Tools required for installation include a level and measuring tape. Tiles can be installed by butt joint or with a reveal.

Clean the wall and tile surface making it free of dirt, oil and debris.

Using a level line and measuring tape, start installing tiles at the base of the design and work up installing towards the ceiling.

If using 3M VHB tape, remove paper backing from one side of the tile and apply tape with generous pressure around the perimeter of the back of the tile.

Remove paper backing from the 'wall side' of the tape and press tile firmly to the wall, applying pressure for 30-60 seconds.

If using industrial adhesive, bead around the perimeter of the back of the tile 1" from the edge. Support or structure may be needed to anchor tiles while adhesive cures. (VHB tape and adhesive can be used together for stronger adhesion.)

