

UNIVERSAL COUPLER HARDWARE

1/4"-20 THREADED COUPLERS ARRIVE INSTALLED ON EACH BAFFLE.

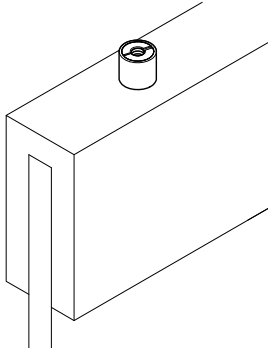

IF NEEDED, THE COUPLER CAN BE DETACHED AND RELOCATED ON-SITE.

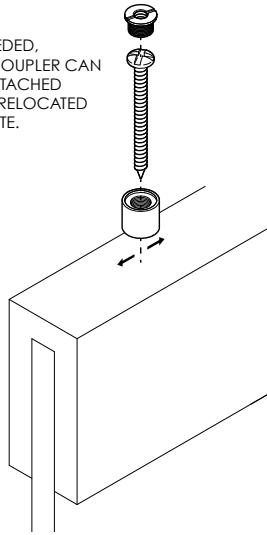

THE COUPLER CAN BE ATTACHED TO ANY 1/4"-20 THREADED SYSTEM. THIS INCLUDES A VARIETY OF CABLE GRIPPERS AND BOLTS.

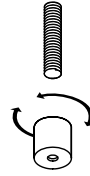

HARDWARE ATTACHMENT BY OTHERS

T-GRID TO CABLE GRIPPER WITH 1/4"-20

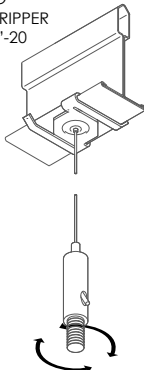

SUSPENDED T-GRID CLAMP WITH 1/4"-20 BOLT

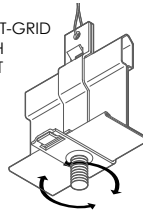

T-GRID CLAMP WITH 1/4"-20 BOLT

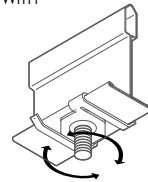

EXTRUDED RAIL TO CABLE GRIPPER

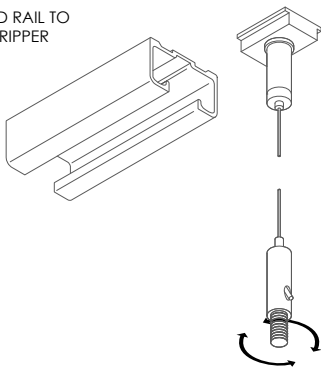

STRUT AND 1/4"-20 SPRING-NUT (SUSPENDED W/ALL-THREAD ROD)

